

System width 50 mm
Interior gaskets
I-Series

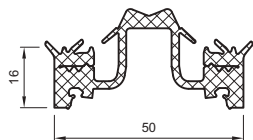

| Article | Material | Surface | No. | PU |
|-----------------------|----------|------------------------|---------------|------|
| Gasket for mullion 50 | EPDM | black, sliding polymer | 150005 | 20 m |

■ **Technical information**

- For THERM⁺ I-series.
- Accessories:
 - Base profile no. 168400 and base profile carrier 50 no. 168405 for steel curtain wall S-I.

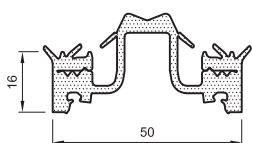

| Article | Material | Surface | No. | PU |
|-----------------------|----------|------------|----------------|------|
| Gasket for mullion 50 | silicone | black, dry | 156005* | 20 m |

■ **Technical information**

- For THERM⁺ I-series.
- Accessories:
 - Base profile no. 168400 and base profile carrier 50 no. 168405 for steel curtain wall S-I.

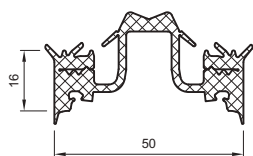

| Article | Material | Surface | No. | PU |
|-------------------------|----------|------------------------|---------------|------|
| Gasket for mullion 50 L | EPDM | black, sliding polymer | 150006 | 20 m |

■ **Technical information**

- For THERM⁺ I-series.
- With collateral lip, for structural profiles with radii.
- Accessories:
 - Base profile no. 168400 and base profile carrier 50 no. 168405.

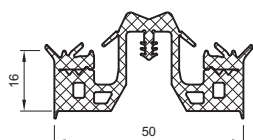

| Article | Material | Surface | No. | PU |
|-------------------------|----------|------------|---------------|------|
| Gasket for mullion 50 D | EPDM | black, dry | 150007 | 20 m |

■ **Technical information**

- Only for steel curtain wall S-I.
- For direct glazing.

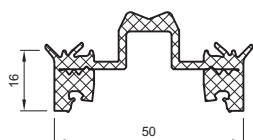

| Article | Material | Surface | No. | PU |
|-----------------------|----------|------------------------|---------------|------|
| Gasket for transom 50 | EPDM | black, sliding polymer | 150010 | 20 m |

■ **Technical information**

- For THERM⁺ I-series.
- Accessories:
 - Base profile no. 168400 and base profile carrier 50 no. 168405 for steel curtain wall S-I.
 - Sealing piece for transom 50 no. 152010 or sealing piece for transom 50 P no. 152080.

System width 50 mm
Interior gaskets
I-Series

| Article | Material | Surface | No. | PU |
|-----------------------|----------|------------|----------------|------|
| Gasket for transom 50 | silicone | black, dry | 156010* | 20 m |

■ **Technical information**

- For THERM⁺ I-series.
- Accessories:
 - Base profile no. 168400 and base profile carrier 50 no. 168405 for steel curtain wall S-I.
 - Sealing piece for transom 50 no. 152010 or sealing piece for transom 50 P no. 152080.

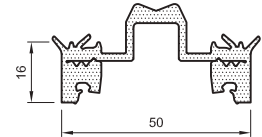

| Article | Material | Surface | No. | PU |
|-------------------------|----------|------------------------|---------------|------|
| Gasket for transom 50 L | EPDM | black, sliding polymer | 150011 | 20 m |

■ **Technical information**

- For THERM⁺ I-series.
- With collateral lip, for tubes with radii.
- Accessories:
 - Base profile no. 168400 and base profile carrier 50 no. 168405.
 - Sealing piece for transom 50 no. 152010 or sealing piece for transom 50 P no. 152080.

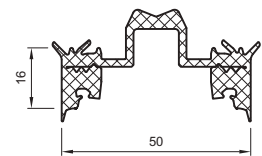

| Article | Material | Surface | No. | PU |
|-------------------------|----------|------------|---------------|------|
| Gasket for transom 50 D | EPDM | black, dry | 150012 | 20 m |

■ **Technical information**

- Only for steel curtain wall S-I.
- For direct glazing.
- Accessories:
 - Sealing piece for transom 50 no. 152010 or sealing piece for transom 50 P no. 152080.

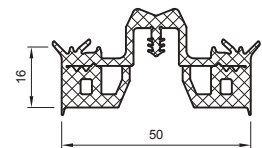

| Article | Material | Surface | No. | PU |
|---------------------------------|----------|------------------------|---------------|------|
| Gasket for transom 50 with flap | EPDM | black, sliding polymer | 150015 | 20 m |

■ **Technical information**

- For THERM⁺ I-series.
- Up to 64 mm infill thickness.
- Accessories:
 - Base profile no. 168400 and base profile carrier 50 no. 168405 for steel curtain wall S-I.
 - Sealing piece for transom 50 no. 152010 or sealing piece for transom 50 P no. 152080.

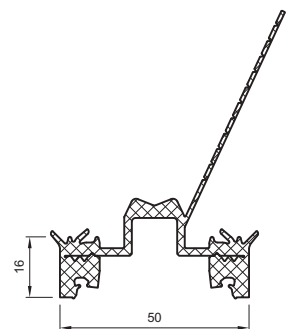

| Article | Material | Surface | No. | PU |
|-----------------------------------|----------|------------------------|----------------|------|
| Gasket for transom 50 L with flap | EPDM | black, sliding polymer | 150016* | 20 m |

■ **Technical information**

- For THERM⁺ I-series.
- With collateral lip, for structural profiles with radii.
- Up to 64 mm infill thickness.
- Accessories:
 - Base profile no. 168400 and base profile carrier 50 no. 168405.
 - Sealing piece for transom 50 no. 152010 or sealing piece for transom 50 P no. 152080.

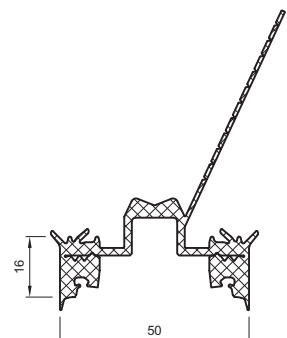

System width 50 mm
Interior gaskets
I-Series

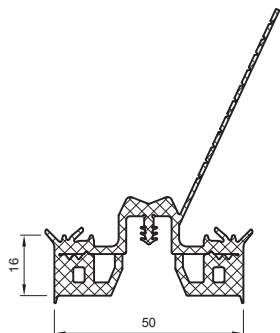

| Article | Material | Surface | No. | PU |
|-----------------------------------|----------|------------|---------------|------|
| Gasket for transom 50 D with flap | EPDM | black, dry | 150017 | 20 m |

■ **Technical information**

- Only for steel curtain wall S-I.
- For direct glazing.
- Up to 64 mm infill thickness.
- Accessories:
 - Sealing piece for transom 50 no. 152010 or sealing piece for transom 50 P no. 152080.

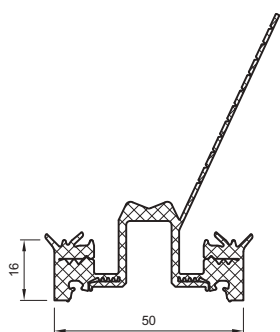

| Article | Material | Surface | No. | PU |
|--------------------------------------|----------|------------------------|---------------|------|
| Base gasket for transom 50 with flap | EPDM | black, sliding polymer | 150020 | 20 m |

■ **Technical information**

- For THERM⁺ I series.
- Up to 64 mm infill thickness.
- Accessories:
 - Base profile no. 168400 and base profile carrier 50 no. 168405 for steel curtain wall S-I.
 - Sealing piece for base transom no. 152071.

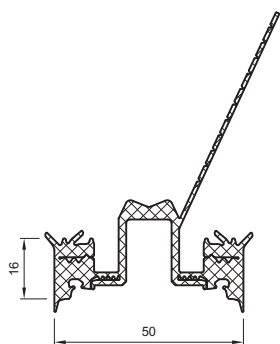

| Article | Material | Surface | No. | PU |
|--|----------|------------------------|----------------|------|
| Base gasket for transom 50 L with flap | EPDM | black, sliding polymer | 150021* | 20 m |

■ **Technical information**

- For THERM⁺ I series.
- With collateral lip, for structural profiles with radii.
- Up to 64 mm infill thickness.
- Accessories:
 - Base profile no. 168400 and base profile carrier 50 no. 168405 for steel curtain wall S-I.
 - Base sealing piece for transom no. 152071.

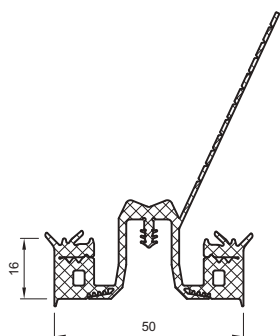

| Article | Material | Surface | No. | PU |
|--|----------|------------|----------------|------|
| Base gasket for transom 50 D with flap | EPDM | black, dry | 150022* | 20 m |

■ **Technical information**

- Only for steel curtain wall S-I.
- For direct glazing.
- Up to 64 mm infill thickness.
- Accessories:
 - Sealing piece for base transom no. 152072.

System width 50 mm
Interior gaskets
I-Series

| Article | Material | Surface | No. | PU |
|-----------------------|----------|------------------------|---------------|------|
| Interior gasket 50 E2 | EPDM | black, sliding polymer | 150013 | 20 m |

■ **Technical information**

- For THERM⁺ I-series.
- Interior gasket for 2nd drainage level.
- Accessories:
 - Base profile no. 168400 and base profile carrier 50 no. 168405 for steel curtain wall S-I.
 - Sealing piece for transom 50 E2 no. 152009 or sealing piece for transom E2 no. 152090.

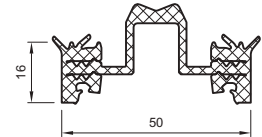

| Article | Material | Surface | No. | PU |
|-------------------------|----------|------------------------|----------------|------|
| Interior gasket 50 L E2 | EPDM | black, sliding polymer | 150014* | 20 m |

■ **Technical information**

- For THERM⁺ I-series.
- Interior gasket for 2nd drainage level.
- With collateral lip, for structural profiles with radii.
- Accessories:
 - Base profile no. 168400 and base profile carrier 50 no. 168405.
 - Sealing piece for transom 50 E2 no. 152009 or sealing piece for transom 50 E2 P no. 152090.

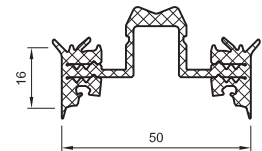

| Article | Material | Surface | No. | PU |
|---------------------------------|----------|------------------------|---------------|------|
| Interior gasket 50 E2 with flap | EPDM | black, sliding polymer | 150018 | 20 m |

■ **Technical information**

- For THERM⁺ I-series.
- Interior gasket for 2nd drainage level.
- Up to 64 mm infill thickness.
- Accessories:
 - Base profile no. 168400 and base profile carrier 50 no. 168405 for steel curtain wall S-I.
 - Sealing piece for transom 50 E2 no. 152009 or sealing piece for transom 50 E2 P no. 152090.

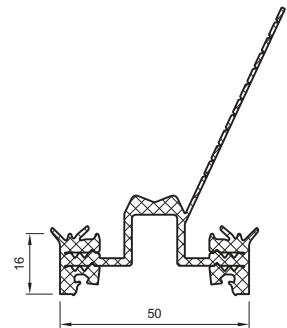

| Article | Material | Surface | No. | PU |
|-----------------------|----------|------------------------|---------------|------|
| Interior gasket 50 E3 | EPDM | black, sliding polymer | 150008 | 20 m |

■ **Technical information**

- For THERM⁺ I-series.
- Interior gasket for 3rd drainage level.
- Accessories:
 - Base profile no. 168400 and base profile carrier 50 no. 168405 for steel curtain wall S-I.

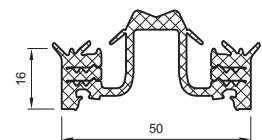

System width 50 mm
Interior gaskets
I-Series

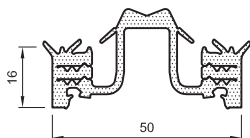

| Article | Material | Surface | No. | PU |
|-----------------------|----------|------------|----------------|------|
| Interior gasket 50 E3 | silicone | black, dry | 156008* | 20 m |

■ **Technical information**

- For THERM⁺ I-series.
- Interior gasket for 3rd drainage level.
- Accessories:
 - Base profile no. 168400 and base profile carrier 50 no. 168405 for steel curtain wall S-I.

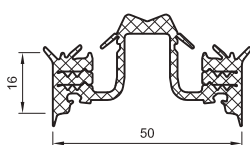

| Article | Material | Surface | No. | PU |
|-------------------------|----------|------------------------|----------------|------|
| Interior gasket 50 L E3 | EPDM | black, sliding polymer | 150009* | 20 m |

■ **Technical information**

- For THERM⁺ I-series.
- Interior gasket for 3rd drainage level.
- With collateral lip, for structural profiles with radii.
- Accessories:
 - Base profile no. 168400 and base profile carrier 50 no. 168405.

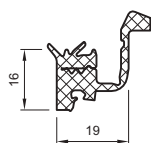

| Article | Material | Surface | No. | PU |
|-------------------------|----------|------------------------|---------------|------|
| Gasket for mullion 50 H | EPDM | black, sliding polymer | 150305 | 40 m |

■ **Technical information**

- For THERM⁺ I-series.
- For expansion profiles or unitised assembly.
- Accessories:
 - Insertion profile 18/14 I no. 168201.

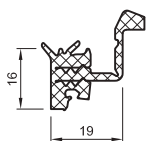

| Article | Material | Surface | No. | PU |
|-------------------------|----------|------------------------|----------------|------|
| Interior gasket 50 H E2 | EPDM | black, sliding polymer | 150313* | 40 m |

■ **Technical information**

- For THERM⁺ I-series.
- For expansion profiles or unitised assembly.
- For 2nd drainage level.
- Accessories:
 - Insertion profile 18/14 I no. 168201.

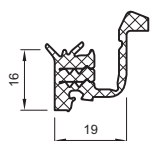

| Article | Material | Surface | No. | PU |
|-------------------------|----------|------------------------|----------------|------|
| Interior gasket 50 H E3 | EPDM | black, sliding polymer | 150308* | 40 m |

■ **Technical information**

- For THERM⁺ I-series.
- For expansion profiles or unitised assembly.
- For 3rd drainage level.
- Accessories:
 - Insertion profile 18/14 I no. 168201.

System width 50 mm
Interior gaskets
I-Series

| Article | Material | Surface | No. | PU |
|---|----------|------------------------|---------------|------|
| Gasket for mullion 50 polygonal 8° to 20° | EPDM | black, sliding polymer | 150040 | 20 m |

■ **Technical information**

- For THERM⁺ I-series.
- Accessories:
 - Base profile no. 168400 and base profile carrier 50 no. 168405 for steel curtain wall S-I.

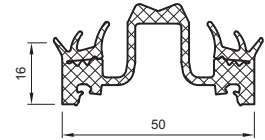

| Article | Material | Surface | No. | PU |
|--|----------|------------------------|----------------|------|
| Gasket for mullion 50 polygonal 21° to 33° | EPDM | black, sliding polymer | 150045* | 20 m |

■ **Technical information**

- For THERM⁺ I-series.
- Accessories:
 - Base profile no. 168400 and base profile carrier 50 no. 168405 for steel curtain wall S-I.

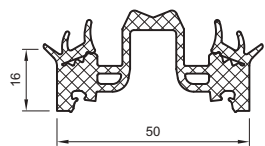

| Article | Material | Surface | No. | PU |
|--|----------|------------------------|----------------|------|
| Gasket for mullion 50 polygonal 34° to 45° | EPDM | black, sliding polymer | 150050* | 20 m |

■ **Technical information**

- For THERM⁺ I-series.
- Accessories:
 - Base profile no. 168400 and base profile carrier 50 no. 168405 for steel curtain wall S-I.

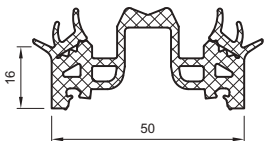

| Article | Material | Surface | No. | PU |
|--------------------------|----------|------------------------|----------------|------|
| Gasket for mullion 50/26 | EPDM | black, sliding polymer | 150461* | 20 m |

■ **Technical information**

- For THERM⁺ I-series.
- For single glazing from 6 mm infill thickness without compensation profiles.
- Interior height 26 mm.
- Accessories:
 - Base profile no. 168400 and base profile carrier 50 no. 168405 for steel curtain wall S-I.
 - Transom sealing piece 50/26 no. 152007.

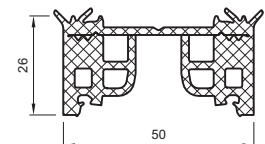

| Article | Material | Surface | No. | PU |
|--------------------------|----------|------------------------|----------------|------|
| Interior gasket 50/26 E3 | EPDM | black, sliding polymer | 150462* | 20 m |

■ **Technical information**

- For THERM⁺ I-series.
- Interior gasket for 3rd drainage level.
- For single glazing from 6 mm infill thickness without compensation profiles.
- Interior height 26 mm.
- Accessories:
 - Base profile no. 168400 and base profile carrier 50 no. 168405 for steel curtain wall S-I.

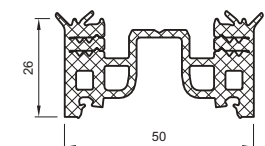

System width 50 mm
Interior gaskets
I-Series

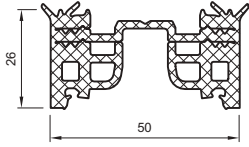

| Article | Material | Surface | No. | PU |
|--------------------------|----------|------------------------|----------------|------|
| Interior gasket 50/26 E2 | EPDM | black, sliding polymer | 150463* | 20 m |

■ **Technical information**

- For THERM⁺ I-series.
- Interior gasket for 2nd drainage level.
- For single glazing from 6 mm infill thickness without compensation profiles.
- Interior height 26 mm.
- Accessories:
 - Base profile no. 168400 and base profile carrier 50 no. 168405 for steel curtain wall S-I.
 - Transom sealing piece 50/26 E2 no. 152011.

System width 50 mm
Interior gaskets
V-Series

| Article | Material | Surface | No. | PU |
|-------------------------|----------|------------------------|---------------|------|
| Gasket for mullion 50 V | EPDM | black, sliding polymer | 153005 | 40 m |

■ **Technical information**

- For THERM⁺ V-series (not in roof area).

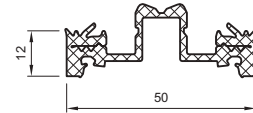

| Article | Material | Surface | No. | PU |
|-------------------------|----------|------------------------|---------------|------|
| Gasket for transom 50 V | EPDM | black, sliding polymer | 153010 | 40 m |

■ **Technical information**

- For THERM⁺ V-series (not in roof area).
- Accessories:
- Sealing piece for transom 50 V no. 152012.

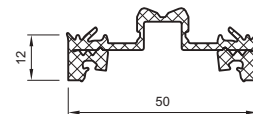

| Article | Material | Surface | No. | PU |
|-----------------------------------|----------|------------------------|---------------|------|
| Gasket for transom 50 V with flap | EPDM | black, sliding polymer | 153015 | 40 m |

■ **Technical information**

- For THERM⁺ V-series (not in roof area).
- Up to 64 mm infill thickness.
- Accessories:
- Sealing piece for transom 50 V no. 152012.

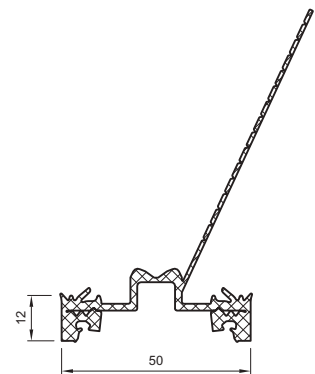

| Article | Material | Surface | No. | PU |
|-------------------------|----------|------------------------|---------------|------|
| Gasket for mullion 50 V | EPDM | black, sliding polymer | 158005 | 40 m |

■ **Technical information**

- For THERM⁺ V-series (not in roof area).
- For compensation of glass thickness with compensation gaskets.

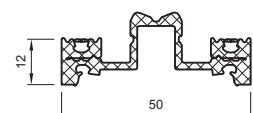

| Article | Material | Surface | No. | PU |
|-------------------------|----------|------------------------|---------------|------|
| Gasket for transom 50 V | EPDM | black, sliding polymer | 158010 | 40 m |

■ **Technical information**

- For THERM⁺ V-series (not in roof area).
- For compensation of glass thickness with compensation gaskets.
- Accessories:
- Sealing piece for transom 50 V no. 152040.

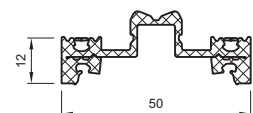

System width 50 mm
Interior gaskets
V-Series

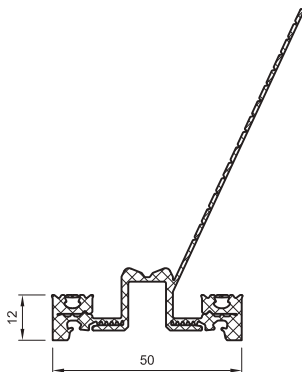

| Article | Material | Surface | No. | PU |
|--|----------|------------------------|---------------|------|
| Base gasket for transom 50 V with flap | EPDM | black, sliding polymer | 158020 | 40 m |

■ **Technical information**

- For THERM⁺ V series (not in roof area).
- Up to 64 mm infill thickness.
- For compensation of glass thickness with compensation gaskets.
- Accessories:
 - Sealing piece for base transom V no. 152075.

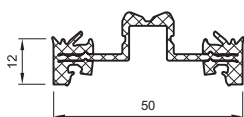

| Article | Material | Surface | No. | PU |
|-------------------------|----------|------------------------|---------------|------|
| Interior gasket 50 E2 V | EPDM | black, sliding polymer | 153013 | 40 m |

■ **Technical information**

- For THERM⁺ V-series (not in roof area).
- Interior gasket for 2nd drainage level.
- Accessories:
 - Sealing piece for transom 50 E2 V no. 152013.

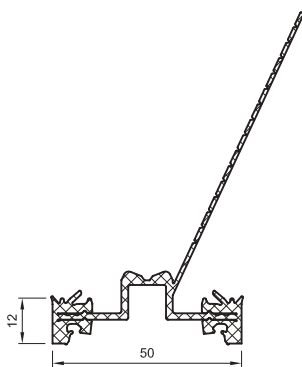

| Article | Material | Surface | No. | PU |
|-----------------------------------|----------|------------------------|----------------|------|
| Interior gasket 50 E2 V with flap | EPDM | black, sliding polymer | 153018* | 40 m |

■ **Technical information**

- For THERM⁺ V-series (not in roof area).
- Interior gasket for 2nd drainage level.
- Up to 64 mm infill thickness.
- Accessories:
 - Sealing piece for transom 50 E2 V no. 152013.

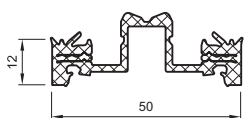

| Article | Material | Surface | No. | PU |
|-------------------------|----------|------------------------|---------------|------|
| Interior gasket 50 E3 V | EPDM | black, sliding polymer | 153008 | 40 m |

■ **Technical information**

- For THERM⁺ V-series (not in roof area).
- Interior gasket for 3rd drainage level.

System width 50 mm
Interior gaskets
V-Series

| Article | Material | Surface | No. | PU |
|--------------------------------------|----------|------------------------|----------------|------|
| Interior gasket 50 E3 V with flap | EPDM | black, sliding polymer | 153009* | 40 m |

■ **Technical information**

- For THERM⁺ V-series (not in roof area).
- Interior gasket for 3rd drainage level.
- Up to 64 mm infill thickness.

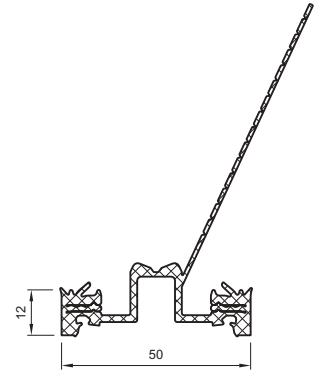

| Article | Material | Surface | No. | PU |
|---|----------|------------------------|---------------|------|
| Base gasket for transom 50 V with flap | EPDM | black, sliding polymer | 153020 | 40 m |

■ **Technical information**

- For THERM⁺ V-series (not in roof area).
- Up to 64 mm infill thickness.
- Accessories:
- Sealing piece for base transom V no. 152075.

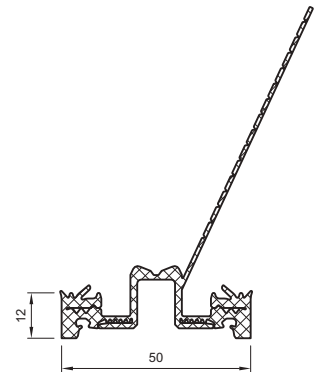

| Article | Material | Surface | No. | PU |
|---------------------------|----------|------------------------|---------------|------|
| Gasket for mullion 50 H V | EPDM | black, sliding polymer | 153305 | 40 m |

■ **Technical information**

- For THERM⁺ V-series (not in roof area).
- For expansion profiles or unitised assembly.
- Accessories:
- Insertion profile 16/10 V no. 168220.

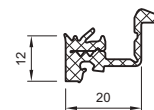

| Article | Material | Surface | No. | PU |
|--|----------|------------------------|---------------|------|
| Gasket for transom 50 V polygonal 8° to 20° | EPDM | black, sliding polymer | 153040 | 40 m |

■ **Technical information**

- For THERM⁺ V-series (not in roof area).

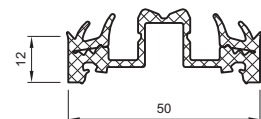

| Article | Material | Surface | No. | PU |
|---|----------|------------------------|----------------|------|
| Gasket for mullion 50 V polygonal 21° to 33° | EPDM | black, sliding polymer | 153045* | 40 m |

■ **Technical information**

- For THERM⁺ V-series (not in roof area).

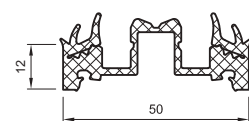

Gaskets

System width 50 mm
Interior gaskets
V-Series

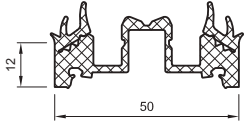

| Article | Material | Surface | No. | PU |
|---|----------|------------------------|----------------|------|
| Gasket for mullion 50 V polygonal 34° to 45° | EPDM | black, sliding polymer | 153050* | 40 m |

■ **Technical information**

- For THERM⁺ A-V and H-V (not in roof area).

System width 56 mm
Interior gaskets
I-Series

| Article | Material | Surface | No. | PU |
|-----------------------|----------|------------------------|---------------|------|
| Gasket for mullion 56 | EPDM | black, sliding polymer | 150105 | 20 m |

■ **Technical information**

- For THERM⁺ I-series.
- Accessories:
 - Base profile no. 168400 and base profile carrier 56 no. 168410 for steel curtain wall S-I.

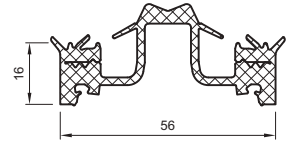

| Article | Material | Surface | No. | PU |
|-----------------------|----------|------------|----------------|------|
| Gasket for mullion 56 | silicone | black, dry | 156105* | 20 m |

■ **Technical information**

- For THERM⁺ I-series.
- Accessories:
 - Base profile no. 168400 and base profile carrier 56 no. 168410 for steel curtain wall S-I.

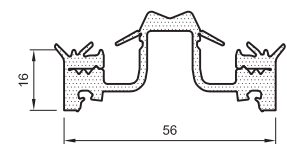

| Article | Material | Surface | No. | PU |
|-------------------------|----------|------------------------|---------------|------|
| Gasket for mullion 56 L | EPDM | black, sliding polymer | 150106 | 20 m |

■ **Technical information**

- For THERM⁺ I-series.
- With collateral lip, for structural profiles with radii.
- Accessories:
 - Base profile no. 168400 and base profile carrier 56 no. 168410.

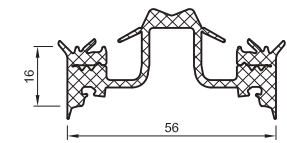

| Article | Material | Surface | No. | PU |
|-------------------------|----------|------------|---------------|------|
| Gasket for mullion 56 D | EPDM | black, dry | 150107 | 20 m |

■ **Technical information**

- Only for steel curtain wall S-I.
- For direct glazing.

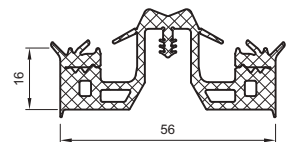

| Article | Material | Surface | No. | PU |
|-----------------------|----------|------------------------|---------------|------|
| Gasket for transom 56 | EPDM | black, sliding polymer | 150110 | 20 m |

■ **Technical information**

- For THERM⁺ I-series.
- Accessories:
 - Base profile no. 168400 and base profile carrier 56 no. 168410 for steel curtain wall S-I.
 - Sealing piece for transom 56 no. 152015 or sealing piece for transom 56 P no. 152082.

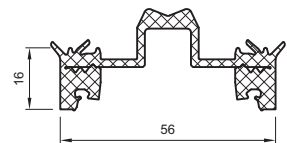

Gaskets

System width 56 mm
Interior gaskets
I-Series

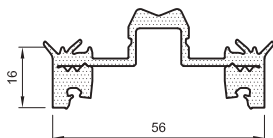

| Article | Material | Surface | No. | PU |
|-----------------------|----------|------------|----------------|------|
| Gasket for transom 56 | silicone | black, dry | 156110* | 20 m |

■ **Technical information**

- For THERM⁺ I-series.
- Accessories:
 - Base profile no. 168400 and base profile carrier 56 no. 168410 for steel curtain wall S-I.
 - Sealing piece for transom 56 no. 152015 or sealing piece for transom 56 P no. 152082.

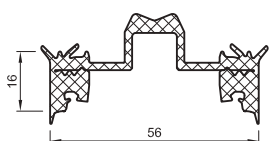

| Article | Material | Surface | No. | PU |
|-------------------------|----------|------------------------|---------------|------|
| Gasket for transom 56 L | EPDM | black, sliding polymer | 150111 | 20 m |

■ **Technical information**

- For THERM⁺ I-series.
- With collateral lip, for tubes with radii.
- Accessories:
 - Base profile no. 168400 and base profile carrier 56 no. 168410.
 - Sealing piece for transom 56 no. 152015 or sealing piece for transom 56 P no. 152082.

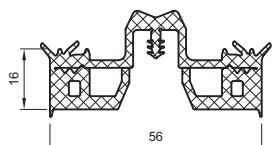

| Article | Material | Surface | No. | PU |
|-------------------------|----------|------------|---------------|------|
| Gasket for transom 56 D | EPDM | black, dry | 150112 | 20 m |

■ **Technical information**

- Only for steel curtain wall S-I.
- For direct glazing.
- Accessories:
 - Sealing piece for transom 56 no. 152015 or sealing piece for transom 56 P no. 152082.

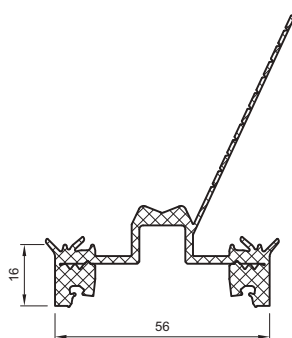

| Article | Material | Surface | No. | PU |
|---------------------------------|----------|------------------------|---------------|------|
| Gasket for transom 56 with flap | EPDM | black, sliding polymer | 150115 | 20 m |

■ **Technical information**

- Up to 64 mm infill thickness.
- Accessories:
 - Base profile no. 168400 and base profile carrier 56 no. 168410 for steel curtain wall S-I.
 - Sealing piece for transom 56 no. 152015 or sealing piece for transom 56 P no. 152082.

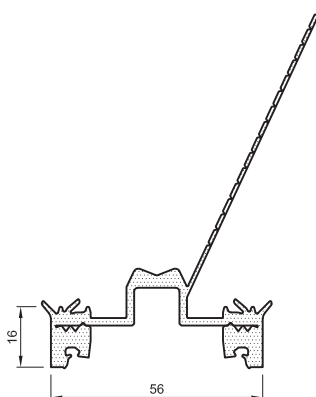

| Article | Material | Surface | No. | PU |
|---------------------------------|----------|------------|----------------|------|
| Gasket for transom 56 with flap | silicone | black, dry | 156115* | 20 m |

■ **Technical information**

- For THERM⁺ I-series.
- Up to 64 mm infill thickness.
- Accessories:
 - Base profile no. 168400 and base profile carrier 56 no. 168410 for steel curtain wall S-I.
 - Sealing piece for transom 56 no. 152015 or sealing piece for transom 56 P no. 152082.

System width 56 mm
Interior gaskets
I-Series

| Article | Material | Surface | No. | PU |
|-----------------------------------|----------|------------------------|----------------|------|
| Gasket for transom 56 L with flap | EPDM | black, sliding polymer | 150116* | 20 m |

■ **Technical information**

- For THERM⁺ I-series.
- With collateral lip, for structural profiles with radii.
- Up to 64 mm infill thickness.
- Accessories:
 - Base profile no. 168400 with base profile carrier 56 no. 168410.
 - Sealing piece for transom 56 no. 152015 or sealing piece for transom 56 P no. 152082.

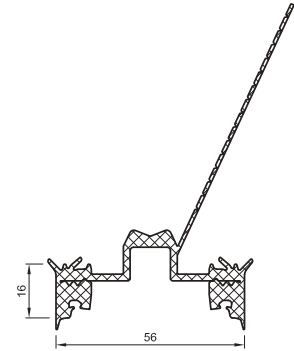

| Article | Material | Surface | No. | PU |
|-----------------------------------|----------|------------|---------------|------|
| Gasket for transom 56 D with flap | EPDM | black, dry | 150117 | 20 m |

■ **Technical information**

- Only for steel curtain wall S-I.
- For direct glazing.
- Up to 64 mm infill thickness.
- Accessories:
 - Sealing piece for transom 56 no. 152015 or sealing piece for transom 56 P no. 152082.

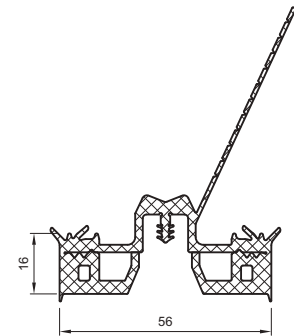

| Article | Material | Surface | No. | PU |
|--------------------------------------|----------|------------|---------------|------|
| Base gasket for transom 56 with flap | silicone | black, dry | 156120 | 20 m |

■ **Technical information**

- For THERM⁺ I series.
- Up to 64 mm infill thickness.
- Accessories:
 - Base profile no. 168400 and base profile carrier 56 no. 168410 for steel curtain wall S-I
 - Sealing element for base transom no. 152071.

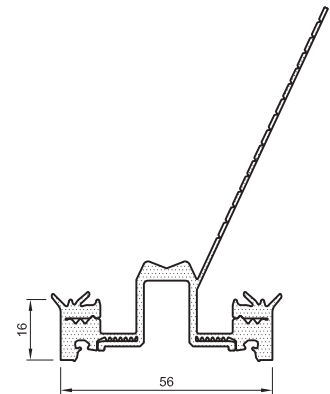

| Article | Material | Surface | No. | PU |
|--------------------------------------|----------|------------------------|----------------|------|
| Base gasket for transom 56 with flap | EPDM | black, sliding polymer | 150120* | 20 m |

■ **Technical information**

- For THERM⁺ I series.
- Up to 64 mm infill thickness.
- Accessories:
 - Base profile no. 168400 and base profile carrier 56 no. 168410 for steel curtain wall S-I.
 - Sealing element for base transom no. 152071.

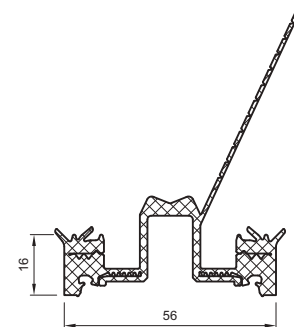

Gaskets

System width 56 mm
Interior gaskets
I-Series

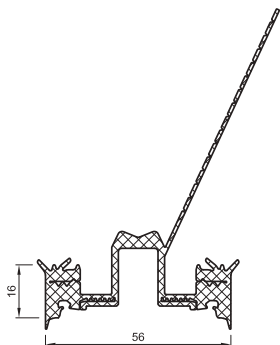

| Article | Material | Surface | No. | PU |
|--|----------|------------------------|----------------|------|
| Base gasket for transom 56 L with flap | EPDM | black, sliding polymer | 150121* | 20 m |

■ **Technical information**

- For THERM⁺ I series.
- With collateral lip, for structural profiles with radii.
- Up to 64 mm infill thickness.
- Accessories:
 - Base profile no. 168400 with base profile carrier 56 no. 168410 for steel curtain wall S-I
 - Sealing piece for transom no. 152071.

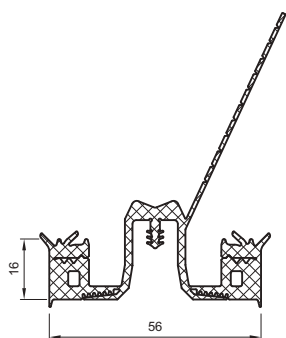

| Article | Material | Surface | No. | PU |
|--|----------|------------|----------------|------|
| Base gasket for transom 56 D with flap | EPDM | black, dry | 150122* | 20 m |

■ **Technical information**

- Only for steel curtain wall S-I.
- For direct glazing.
- Up to 64 mm infill thickness.
- Accessories:
 - Sealing piece for base transom no. 152072.

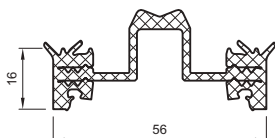

| Article | Material | Surface | No. | PU |
|-----------------------|----------|------------------------|---------------|------|
| Interior gasket 56 E2 | EPDM | black, sliding polymer | 150113 | 20 m |

■ **Technical information**

- For THERM⁺ I-series.
- Interior gasket for 2nd drainage level.
- Accessories:
 - Base profile no. 168400 and base profile carrier 56 no. 168410 for steel curtain wall S-I
 - Sealing piece for transom 56 E2 no. 152014 or sealing piece for transom 56 E2 P no. 152092.

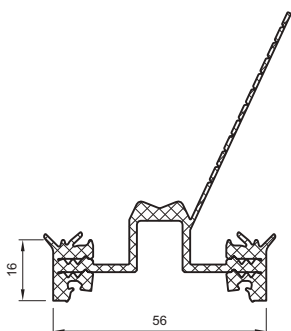

| Article | Material | Surface | No. | PU |
|---------------------------------|----------|------------------------|---------------|------|
| Interior gasket 56 E2 with flap | EPDM | black, sliding polymer | 150118 | 20 m |

■ **Technical information**

- For THERM⁺ I-series.
- Interior gasket for 2nd drainage level.
- Up to 64 mm infill thickness.
- Accessories:
 - Base profile no. 168400 and base profile carrier 56 no. 168410 for steel curtain wall S-I
 - Sealing piece for transom 56 E2 no. 152014 or sealing piece for transom 56 E2 P no. 152092.

System width 56 mm
Interior gaskets
I-Series

| Article | Material | Surface | No. | PU |
|-----------------------|----------|------------------------|---------------|------|
| Interior gasket 56 E3 | EPDM | black, sliding polymer | 150108 | 20 m |

■ **Technical information**

- For THERM⁺ I-series.
- Interior gasket for 3rd drainage level.
- Accessories:
 - Base profile no. 168400 and base profile carrier 56 no. 168410 for steel curtain wall S-I.

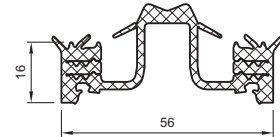

| Article | Material | Surface | No. | PU |
|---------------------------------|----------|------------------------|----------------|------|
| Gasket for transom 56 with flap | EPDM | black, sliding polymer | 150085* | 20 m |

■ **Technical information**

- For THERM⁺ I-series.
- Up to 64 mm infill thickness.
- Accessories:
 - Sealing piece for transom no. 152080.

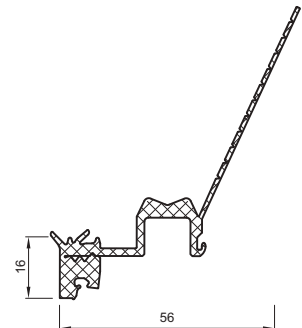

| Article | Material | Surface | No. | PU |
|-------------------------|----------|------------------------|---------------|------|
| Gasket for mullion 56 H | EPDM | black, sliding polymer | 150335 | 40 m |

■ **Technical information**

- For THERM⁺ I-series.
- For expansion profiles or unitised assembly.
- Accessories:
 - Insertion profile 18/14 I no. 168201.

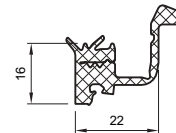

| Article | Material | Surface | No. | PU |
|---|----------|------------------------|---------------|------|
| Gasket for mullion 56 polygonal 8° to 20° | EPDM | black, sliding polymer | 150140 | 20 m |

■ **Technical information**

- For THERM⁺ I-series.
- Accessories:
 - Base profile no. 168400 and base profile carrier 56 no. 168410 for steel curtain wall S-I.

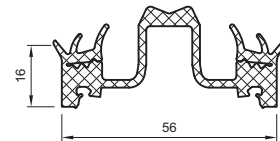

| Article | Material | Surface | No. | PU |
|--|----------|------------------------|----------------|------|
| Gasket for mullion 56 polygonal 21° to 33° | EPDM | black, sliding polymer | 150145* | 20 m |

■ **Technical information**

- For THERM⁺ I-series.
- Accessories:
 - Base profile no. 168400 and base profile carrier 56 no. 168410 for steel curtain wall S-I.

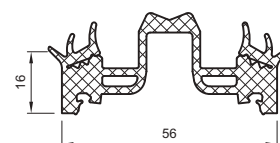

System width 56 mm
Interior gaskets
I-Series

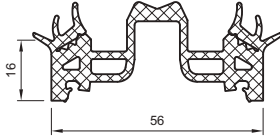

| Article | Material | Surface | No. | PU |
|---|----------|------------------------|----------------|------|
| Gasket for mullion 56 polygonal 34° to 45° | EPDM | black, sliding polymer | 150150* | 20 m |

■ **Technical information**

- For THERM⁺ I-series.
- Accessories:
 - Base profile no. 168400 and base profile carrier 56 no. 168410 for steel curtain wall S-I.

System width 56 mm
Interior gaskets
V-Series

| Article | Material | Surface | No. | PU |
|-------------------------|----------|------------------------|---------------|------|
| Gasket for mullion 56 V | EPDM | black, sliding polymer | 153105 | 40 m |

■ **Technical information**

- For THERM⁺ V-series (not in roof area).

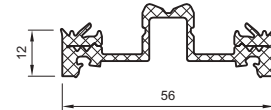

| Article | Material | Surface | No. | PU |
|-------------------------|----------|------------|----------------|------|
| Gasket for mullion 56 V | silicone | black, dry | 156605* | 20 m |

■ **Technical information**

- For THERM⁺ V-series (not in roof area).

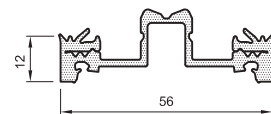

| Article | Material | Surface | No. | PU |
|-------------------------|----------|------------------------|---------------|------|
| Gasket for transom 56 V | EPDM | black, sliding polymer | 153110 | 40 m |

■ **Technical information**

- For THERM⁺ V-series (not in roof area).
- Accessories:
 - Sealing piece for transom 56 V no. 152017.

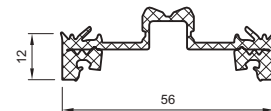

| Article | Material | Surface | No. | PU |
|-----------------------------------|----------|------------------------|---------------|------|
| Gasket for transom 56 V with flap | EPDM | black, sliding polymer | 153115 | 40 m |

■ **Technical information**

- For THERM⁺ V-series (not in roof area).
- Up to 64 mm infill thickness.
- Accessories:
 - Sealing piece for transom 56 V no. 152017.

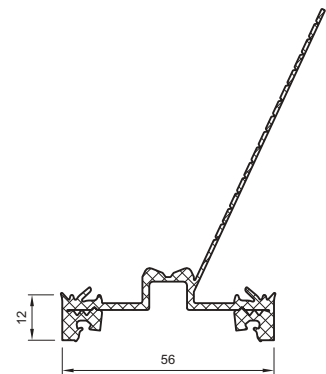

| Article | Material | Surface | No. | PU |
|-----------------------------------|----------|------------|----------------|------|
| Gasket for transom 56 V with flap | silicone | black, dry | 156615* | 20 m |

■ **Technical information**

- For THERM⁺ V-series (not in roof area).
- Up to 64 mm infill thickness.
- Accessories:
 - Sealing piece for transom 56 V no. 152017.

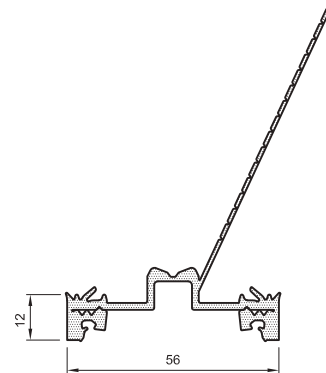

System width 56 mm
Interior gaskets
V-Series

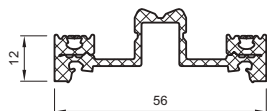

| Article | Material | Surface | No. | PU |
|-------------------------|----------|------------------------|---------------|------|
| Gasket for mullion 56 V | EPDM | black, sliding polymer | 158105 | 40 m |

■ **Technical information**

- For THERM⁺ V-series (not in roof area).
- For compensation of glass thickness with compensation gaskets.

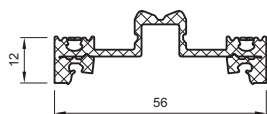

| Article | Material | Surface | No. | PU |
|-------------------------|----------|------------------------|---------------|------|
| Gasket for transom 56 V | EPDM | black, sliding polymer | 158110 | 40 m |

■ **Technical information**

- For THERM⁺ V-series (not in roof area).
- For compensation of glass thickness with compensation gaskets.
- Accessories:
 - Sealing piece for transom 56 V no. 152045.

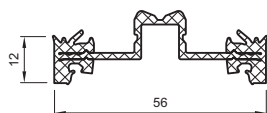

| Article | Material | Surface | No. | PU |
|-------------------------|----------|------------------------|----------------|------|
| Interior gasket 56 E2 V | EPDM | black, sliding polymer | 153113* | 40 m |

■ **Technical information**

- For THERM⁺ V-series (not in roof area).
- Interior gasket for 2nd drainage level.
- Accessories:
 - Sealing piece for transom 56 E2 V no. 152018.

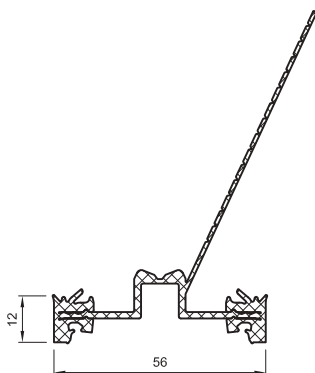

| Article | Material | Surface | No. | PU |
|-----------------------------------|----------|------------------------|----------------|------|
| Interior gasket 56 E2 V with flap | EPDM | black, sliding polymer | 153118* | 40 m |

■ **Technical information**

- For THERM⁺ V-series (not in roof area).
- Interior gasket for 2nd drainage level.
- Up to 64 mm infill thickness.
- Accessories:
 - Sealing piece for transom 56 E2 V no. 152018.

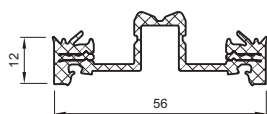

| Article | Material | Surface | No. | PU |
|-------------------------|----------|------------------------|----------------|------|
| Interior gasket 56 E3 V | EPDM | black, sliding polymer | 153108* | 40 m |

■ **Technical information**

- For THERM⁺ V-series (not in roof area).
- Interior gasket for 3rd drainage level.

System width 56 mm
Interior gaskets
V-Series

| Article | Material | Surface | No. | PU |
|--|----------|------------------------|---------------|------|
| Base gasket for transom 56 V with flap | EPDM | black, sliding polymer | 153120 | 40 m |

■ **Technical information**

- For THERM⁺ V-series (not in roof area).
- Up to 64 mm infill thickness.
- Accessories:
 - Sealing element for base transom V no. 152075.

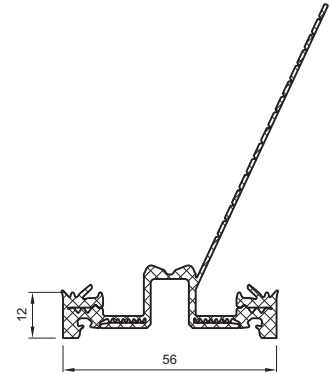

| Article | Material | Surface | No. | PU |
|---------------------------|----------|------------------------|---------------|------|
| Gasket for mullion 56 H V | EPDM | black, sliding polymer | 153335 | 40 m |

■ **Technical information**

- For THERM⁺ V-series (not in roof area).
- For expansion profiles or unitised assembly.
- Accessories:
 - Insertion profile 16/10 V no. 168220.

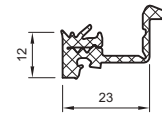

| Article | Material | Surface | No. | PU |
|---|----------|------------------------|---------------|------|
| Gasket for transom 56 V polygonal 8° to 20° | EPDM | black, sliding polymer | 153140 | 40 m |

■ **Technical information**

- For THERM⁺ V-series (not in roof area).

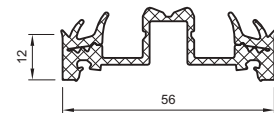

| Article | Material | Surface | No. | PU |
|--|----------|------------------------|----------------|------|
| Gasket for mullion 56 V polygonal 21° to 33° | EPDM | black, sliding polymer | 153145* | 40 m |

■ **Technical information**

- For THERM⁺ V-series (not in roof area).

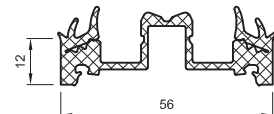

| Article | Material | Surface | No. | PU |
|--|----------|------------------------|---------------|------|
| Gasket for mullion 56 V polygonal 34° to 45° | EPDM | black, sliding polymer | 153150 | 40 m |

■ **Technical information**

- For THERM⁺ V-series (not in roof area).

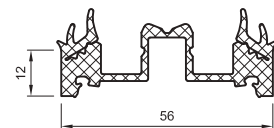

System width 76 mm
Interior gaskets
I-Series

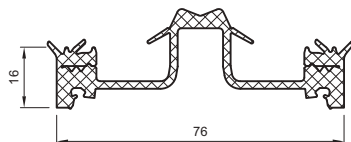

| Article | Material | Surface | No. | PU |
|-----------------------|----------|------------------------|---------------|------|
| Gasket for mullion 76 | EPDM | black, sliding polymer | 150205 | 20 m |

■ **Technical information**

- For THERM⁺ H-I and S-I.
- Accessories:
 - Base profile no. 168400 and base profile carrier 76 no. 168415 for steel curtain wall S-I.

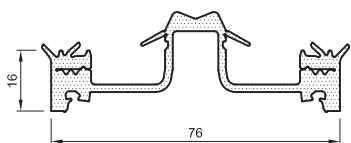

| Article | Material | Surface | No. | PU |
|-----------------------|----------|------------|----------------|------|
| Gasket for mullion 76 | silicone | black, dry | 156405* | 20 m |

■ **Technical information**

- For THERM⁺ H-I and S-I.
- Accessories:
 - Base profile no. 168400 and base profile carrier 76 no. 168415 for steel curtain wall S-I.

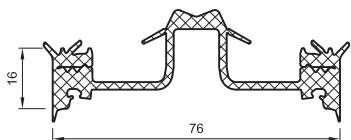

| Article | Material | Surface | No. | PU |
|-------------------------|----------|------------------------|----------------|------|
| Gasket for mullion 76 L | EPDM | black, sliding polymer | 150206* | 20 m |

■ **Technical information**

- For THERM⁺ H-I, S-I and FS-I.
- With collateral lip, for structural profiles with radii.
- Accessories:
 - Base profile no. 168400 with base profile carrier 76 no. 168415.

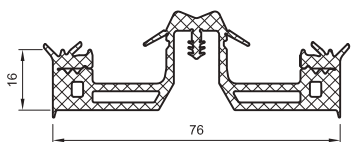

| Article | Material | Surface | No. | PU |
|-------------------------|----------|------------|---------------|------|
| Gasket for mullion 76 D | EPDM | black, dry | 150207 | 20 m |

■ **Technical information**

- Only for steel curtain wall S-I.
- For direct glazing.

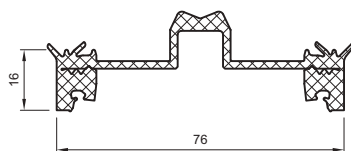

| Article | Material | Surface | No. | PU |
|-----------------------|----------|------------------------|---------------|------|
| Gasket for transom 76 | EPDM | black, sliding polymer | 150210 | 20 m |

■ **Technical information**

- For THERM⁺ H-I and S-I.
- Accessories:
 - Base profile no. 168400 and base profile carrier 76 no. 168415 for steel curtain wall S-I
 - Sealing piece for transom 76 no. 152020 or sealing piece for transom 76 P no. 152084.

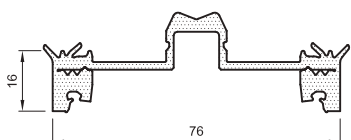

| Article | Material | Surface | No. | PU |
|-----------------------|----------|------------|----------------|------|
| Gasket for transom 76 | silicone | black, dry | 156410* | 20 m |

■ **Technical information**

- For THERM⁺ H-I and S-I.
- Accessories:
 - Base profile no. 168400 and base profile carrier 76 no. 168415 for steel curtain wall S-I
 - Sealing piece for transom 76 no. 152020 or sealing piece for transom 76 P no. 152084.

System width 76 mm
Interior gaskets
I-Series

| Article | Material | Surface | No. | PU |
|-------------------------|----------|------------|----------------|------|
| Gasket for transom 76 D | EPDM | black, dry | 150212* | 20 m |

■ **Technical information**

- Only for steel curtain wall S-I.
- For direct glazing.
- Accessories:
 - Sealing piece for transom 76 no. 152020 or sealing piece for transom 76 P no. 152084.

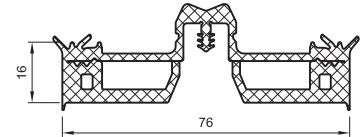

| Article | Material | Surface | No. | PU |
|-----------------------|----------|------------------------|----------------|------|
| Interior gasket 76 E2 | EPDM | black, sliding polymer | 150213* | 20 m |

■ **Technical information**

- For THERM⁺ H-I and S-I.
- Interior gasket for 2nd drainage level.
- Accessories:
 - Base profile no. 168400 and base profile carrier 76 no. 168415 for steel curtain wall S-I.
 - Sealing piece for transom 76 E2 no. 152019 or sealing piece for transom 76 E2 P no. 152094.

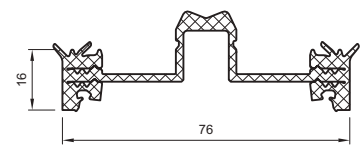

| Article | Material | Surface | No. | PU |
|---------------------------------|----------|------------------------|---------------|------|
| Gasket for transom 76 with flap | EPDM | black, sliding polymer | 150215 | 20 m |

■ **Technical information**

- For THERM⁺ H-I and A-I.
- Up to 64 mm infill thickness.
- Accessories:
 - Base profile no. 168400 and base profile carrier 76 no. 168415 for steel curtain wall S-I
 - Sealing piece for transom 76 no. 152020 or sealing piece for transom 76 P no. 152084.

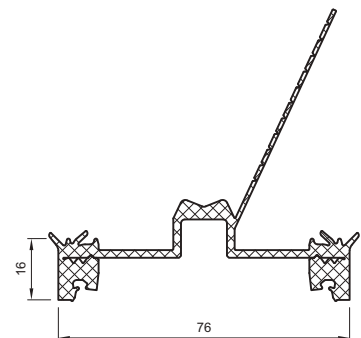

| Article | Material | Surface | No. | PU |
|---------------------------------|----------|------------|----------------|------|
| Gasket for transom 76 with flap | silicone | black, dry | 156415* | 20 m |

■ **Technical information**

- For THERM⁺ H-I and A-I.
- Up to 64 mm infill thickness.
- Accessories:
 - Base profile no. 168400 and base profile carrier 76 no. 168415 for steel curtain wall S-I
 - Sealing piece for transom 76 no. 152020 or sealing piece for transom 76 P no. 152084.

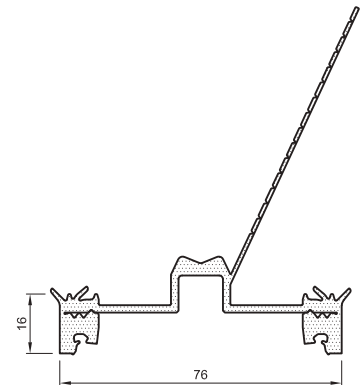

Gaskets

System width 76 mm
Interior gaskets
I-Series

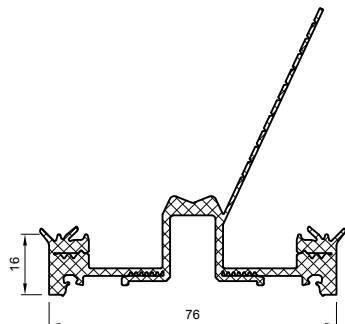

| Article | Material | Surface | No. | PU |
|--------------------------------------|----------|------------------------|---------------|------|
| Base gasket for transom 76 with flap | EPDM | black, sliding polymer | 150220 | 20 m |

■ **Technical information**

- For THERM⁺ H-I and A-I.
- Up to 64 mm infill thickness.
- Accessories:
 - Base profile no. 168400 and base profile carrier 76 no. 168415 for steel curtain wall S-I
 - Sealing piece for base transom no. 152071.

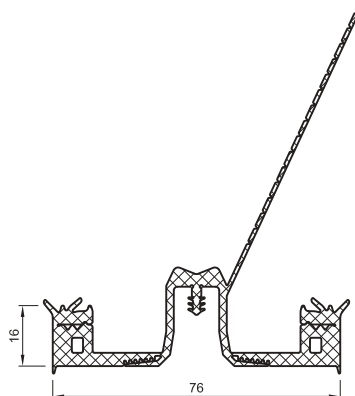

| Article | Material | Surface | No. | PU |
|--|----------|---------|----------------|------|
| Base gasket for transom 76 D with flap | EPDM | black | 150222* | 20 m |

■ **Technical information**

- Only for steel curtain wall S-I.
- For direct glazing.
- Up to 64 mm infill thickness.
- Accessories:
 - Sealing piece for base transom 76 no. 152072.

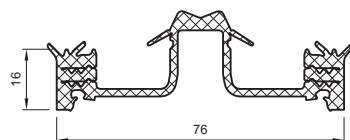

| Article | Material | Surface | No. | PU |
|-----------------------|----------|------------------------|----------------|------|
| Interior gasket 76 E3 | EPDM | black, sliding polymer | 150208* | 20 m |

■ **Technical information**

- For THERM⁺ H-I and S-I.
- Interior gasket for 3rd drainage level.
- Accessories:
 - Base profile no. 168400 and base profile carrier 76 no. 168415 for steel curtain wall S-I.

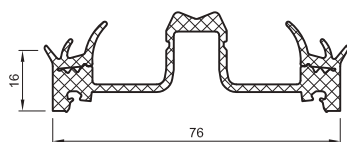

| Article | Material | Surface | No. | PU |
|---|----------|------------------------|----------------|------|
| Gasket for mullion 76 polygonal 8° to 20° | EPDM | black, sliding polymer | 150240* | 20 m |

■ **Technical information**

- For THERM⁺ H-I and S-I.
- Accessories:
 - Base profile no. 168400 and base profile carrier 76 no. 168415 for steel curtain wall S-I.

System width 76 mm
Interior gaskets
V-Series

| Article | Material | Surface | No. | PU |
|-------------------------|----------|------------------------|----------------|------|
| Gasket for mullion 76 V | EPDM | black, sliding polymer | 153205* | 40 m |

■ **Technical information**

- For THERM⁺ H-V (not in roof area).

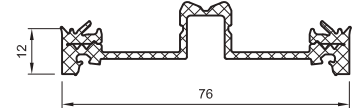

| Article | Material | Surface | No. | PU |
|-------------------------|----------|------------------------|----------------|------|
| Gasket for transom 76 V | EPDM | black, sliding polymer | 153210* | 40 m |

■ **Technical information**

- For THERM⁺ H-V (not in roof area).
- Accessories:
- Sealing piece for transom 76 V no. 152058.

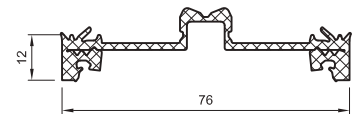

System width 96 mm
Interior gaskets
I-Series

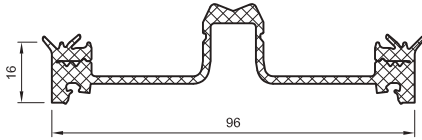

| Article | Material | Surface | No. | PU |
|-----------------------|----------|------------------------|---------------|------|
| Gasket for mullion 96 | EPDM | black, sliding polymer | 150705 | 20 m |

- **Technical information**
 - Only for THERM⁺ H-I.

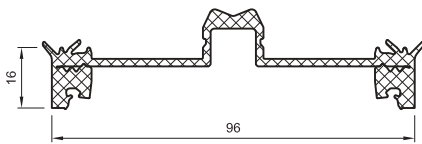

| Article | Material | Surface | No. | PU |
|-----------------------|----------|------------------------|---------------|------|
| Gasket for transom 96 | EPDM | black, sliding polymer | 150710 | 20 m |

- **Technical information**
 - Only for THERM⁺ H-I.
 - Accessories:
 - Sealing piece for transom 96 P no. 152086.

System width 50/56/76/96 mm

Exterior gaskets
I-Series/V-Series

| Article | Material | Surface | No. | PU |
|--------------------------------|----------|------------------------|------------------|-------|
| Gasket for pressure profile 3 | EPDM | black, sliding polymer | 011070.LI | 100 m |
| Gasket for pressure profile 3 | EPDM | black, sliding polymer | 011070.RE | 100 m |
| Gasket for pressure profile 4 | EPDM | black, sliding polymer | 011077 | 100 m |
| Gasket for pressure profile 5 | EPDM | black, sliding polymer | 011073 | 100 m |
| Gasket for pressure profile 6 | EPDM | black, sliding polymer | 011076 | 100 m |
| Gasket for pressure profile 7 | EPDM | black, sliding polymer | 011074 | 100 m |
| Gasket for pressure profile 8 | EPDM | black, sliding polymer | 011071 | 100 m |
| Gasket for pressure profile 9 | EPDM | black, sliding polymer | 011075 | 100 m |
| Gasket for pressure profile 11 | EPDM | black, sliding polymer | 011072 | 100 m |
| Gasket for pressure profile 13 | EPDM | black, sliding polymer | 011078 | 50 m |

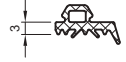

■ **Technical information**

- For all standard pressure profiles.
- LI = rolled up left.
- RE = rolled up right.

| Article | Material | Surface | No. | PU |
|-------------------------------|----------|------------|---------------|-------|
| Gasket for pressure profile 3 | silicone | black, dry | 011270 | 100 m |
| Gasket for pressure profile 5 | silicone | black, dry | 011273 | 100 m |



■ **Technical information**

- For all standard pressure profiles.

| Article | Material | Surface | No. | PU |
|-------------------|----------|------------|---------------|-------|
| Exterior gasket 3 | EPDM | black, dry | 011059 | 100 m |

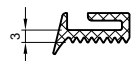

■ **Technical information**

- For special constructions with 2 to 3 mm sheet metal parts.

| Article | Material | Surface | No. | PU |
|----------------------------------|----------|-----------------|---------------|-------|
| Gasket for pressure profile 3/16 | silicone | black, adhesive | 220203 | 200 m |
| Gasket for pressure profile 3/16 | EPDM | black, adhesive | 220204 | 200 m |

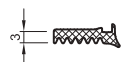

■ **Technical information**

- For flat pressure profiles.

| Article | Material | Surface | No. | PU |
|----------------------------------|----------|-----------------|---------------|-------|
| Gasket for pressure profile 2/16 | EPDM | black, adhesive | 220205 | 100 m |
| Pressure profile gasket 2/16 | silicone | black, adhesive | 220208 | 100 m |

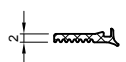

■ **Technical information**

- For flat pressure profiles.

System width 50/56/76/96 mm

Exterior gaskets
I-Series/V-Series

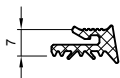

| Article | Material | Surface | No. | PU |
|---------------------------------|----------|------------|---------------|-------|
| Gasket for pressure profile 7 H | EPDM | black, dry | 150510 | 100 m |

■ **Technical information**

- For use with pressure profile no. 118505, 118510, 118515.
- For applications with timber cover profile.

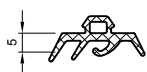

| Article | Material | Surface | No. | PU |
|---|----------|------------------------|---------------|-------|
| Gasket for pressure profile 5 polygonal | EPDM | black, sliding polymer | 011805 | 100 m |

■ **Technical information**

- For polygonal profiles no. 013800, 013801, 013802.

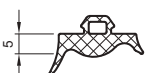

| Article | Material | Surface | No. | PU |
|---------------------------------------|----------|------------------------|---------------|-------|
| Gasket for pressure profile 8° to 15° | EPDM | black, sliding polymer | 011810 | 100 m |

■ **Technical information**

- For all standard pressure profiles.



| Article | Material | Surface | No. | PU |
|--|----------|-----------------|---------------|-------|
| Gasket for pressure profile 3 polygonal 3° to 7° | EPDM | black, adhesive | 011850 | 200 m |

■ **Technical information**

- For flat pressure profiles.

System width 50/56/76/96 mm
Exterior gaskets
I-Series/V-Series

| Article | Material | Surface | No. | PU |
|--------------------|----------|------------------------|---------------|-------|
| Interior gasket 3 | EPDM | black, sliding polymer | 220320 | 100 m |
| Interior gasket 4 | EPDM | black, sliding polymer | 220346 | 100 m |
| Interior gasket 5 | EPDM | black, sliding polymer | 220321 | 100 m |
| Interior gasket 6 | EPDM | black, sliding polymer | 220347 | 100 m |
| Interior gasket 7 | EPDM | black, sliding polymer | 220322 | 100 m |
| Interior gasket 8 | EPDM | black, sliding polymer | 220348 | 100 m |
| Interior gasket 9 | EPDM | black, sliding polymer | 220323 | 100 m |
| Interior gasket 10 | EPDM | black, sliding polymer | 220349 | 100 m |
| Interior gasket 11 | EPDM | black, sliding polymer | 220324 | 75 m |
| Interior gasket 12 | EPDM | black, sliding polymer | 220350 | 100 m |
| Interior gasket 13 | EPDM | black, sliding polymer | 220325 | 75 m |
| Interior gasket 14 | EPDM | black, sliding polymer | 220351 | 50 m |
| Interior gasket 15 | EPDM | black, sliding polymer | 220326 | 50 m |
| Interior gasket 17 | EPDM | black, sliding polymer | 220327 | 50 m |

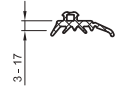

■ **Technical information**

- For the interior compensation of varying infill thicknesses with no. 116005.

| Article | Material | Surface | No. | PU |
|------------------------|----------|------------------------|---------------|-------|
| Compensation gasket 2 | EPDM | black, sliding polymer | 227010 | 100 m |
| Compensation gasket 4 | EPDM | black, sliding polymer | 227015 | 100 m |
| Compensation gasket 6 | EPDM | black, sliding polymer | 227020 | 100 m |
| Compensation gasket 8 | EPDM | black, sliding polymer | 227025 | 100 m |
| Compensation gasket 10 | EPDM | black, sliding polymer | 227030 | 100 m |

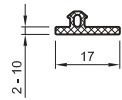

■ **Technical information**

- For the compensation of varying infill thicknesses.

| Article | Material | Surface | No. | PU |
|-----------------------|----------|------------------------|---------------|-------|
| Compensation gasket 9 | EPDM | black, sliding polymer | 227032 | 100 m |

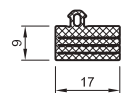

■ **Technical information**

- For the compensation of varying infill thicknesses.
- Gasket easy to tear off to 3/5/7 mm.

| Article | Material | Surface | No. | PU |
|-----------------------|----------|------------------------|---------------|-------|
| Compensation gasket 2 | EPDM | black, sliding polymer | 011080 | 100 m |

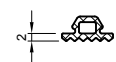

■ **Technical information**

- For the compensation of varying infill thicknesses.

System width 50/56/76/96 mm

Exterior gaskets

I-Series/V-Series



| Article | Material | Surface | No. | PU |
|-----------------------|----------|------------------------|---------------|-------|
| Compensation gasket 2 | EPDM | black, sliding polymer | 154505 | 100 m |
| Compensation gasket 4 | EPDM | black, sliding polymer | 154507 | 100 m |
| Compensation gasket 6 | EPDM | black, sliding polymer | 154509 | 100 m |

■ **Technical information**

- For THERM⁺ H-V and A-V (not in roof area).
- For the interior compensation of varying infill thicknesses.

System width 50/56/76/96 mm
Additional gaskets
I-Series/V-Series

| Article | Material | Surface | No. | PU |
|------------------------------|----------|------------------------|---------------|-------|
| Gasket for expansion mullion | EPDM | black, sliding polymer | 011120 | 100 m |

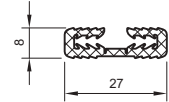

■ **Technical information**

- Double gasket (with tear-off point).
- For sheets with a thickness of 2 mm.

| Article | Material | Surface | No. | PU |
|------------------------------|----------|------------------------|---------------|-------|
| Gasket for expansion mullion | EPDM | black, sliding polymer | 152005 | 100 m |

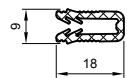

■ **Technical information**

- For THERM⁺ A-I and A-V (V not in roof area).
- For expansion profiles.
- For sheets with a thickness of 2 mm.

| Article | Material | Surface | No. | PU |
|---------------------|----------|------------|---------------|------|
| Connection gasket 8 | EPDM | black, dry | 054500 | 20 m |

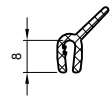

■ **Technical information**

- For sheets with a thickness of 2 mm.

| Article | Material | Surface | No. | PU |
|------------------------|----------|------------|---------------|------|
| T-connection gasket 10 | TPE | black, dry | 054501 | 20 m |

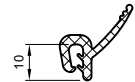

■ **Technical information**

- For sheets with a thickness of 2 mm.

| Article | Material | Surface | No. | PU |
|---------------------|----------|--------------------|---------------|----------|
| Slide-in gasket 8/3 | EPDM | black, siliconised | 167013 | 10 pc(s) |

■ **Technical information**

- For a clearance-free sliding of the RAICO insertion profiles.
- Length: 100 mm.



| Article | Material | Surface | No. | PU |
|---------|----------|------------|---------------|-------|
| Rope 4 | EPDM | black, dry | 220070 | 200 m |

■ **Technical information**

- For fixation profile no. 014401.



System width 50/56/76 mm
Insulating blocks
I-Series/V-Series

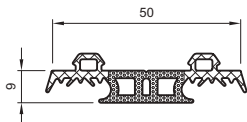

| Article | Material | Surface | No. | PU |
|-----------------------|----------|------------------------|---------------|------|
| Insulating block 50/9 | EPDM | black, sliding polymer | 151010 | 50 m |

■ **Technical information**

- For pressure profiles with a system width of 50 mm.

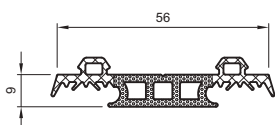

| Article | Material | Surface | No. | PU |
|-----------------------|----------|------------------------|---------------|------|
| Insulating block 56/9 | EPDM | black, sliding polymer | 151020 | 50 m |

■ **Technical information**

- For pressure profiles with a system width of 56 mm.

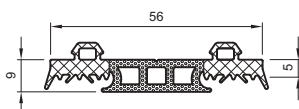

| Article | Material | Surface | No. | PU |
|-------------------------|----------|------------------------|---------------|------|
| Insulating block 56/9/5 | EPDM | black, sliding polymer | 151021 | 50 m |

■ **Technical information**

- For pressure profiles with a system width of 56 mm.

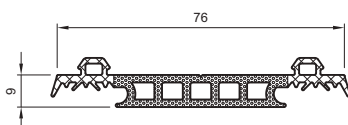

| Article | Material | Surface | No. | PU |
|-----------------------|----------|------------------------|---------------|------|
| Insulating block 76/9 | EPDM | black, sliding polymer | 151030 | 50 m |

■ **Technical information**

- For pressure profiles with a system width of 76 mm.

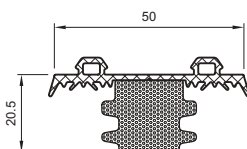

| Article | Material | Surface | No. | PU |
|------------------------|-------------------|------------------------|---------------|------|
| Insulating block 50/21 | EPDM/Polyethylene | black, sliding polymer | 150605 | 50 m |

■ **Technical information**

- For pressure profiles with a system width of 50 mm.

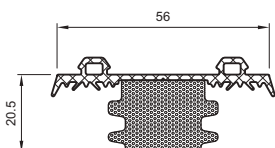

| Article | Material | Surface | No. | PU |
|------------------------|-------------------|------------------------|---------------|------|
| Insulating block 56/21 | EPDM/Polyethylene | black, sliding polymer | 150610 | 50 m |

■ **Technical information**

- For pressure profiles with a system width of 56 mm.

System width 50/56/76 mm
Insulating blocks
I-Series/V-Series

| Article | Material | Surface | No. | PU |
|--------------------------|--------------|---------|---------------|------|
| Insulating block P 50/19 | polyethylene | - | 168509 | 50 m |

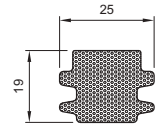

■ **Technical information**

- For system width 50 mm.
- One-side adhesive.
- Delivery in 25 bars each with a length of 2 m.
- Assembly in combination with exterior gasket 3 to 5 mm.

| Article | Material | Surface | No. | PU |
|--------------------------|--------------|---------|---------------|------|
| Insulating block P 50/25 | polyethylene | - | 168510 | 50 m |

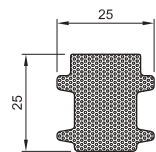

■ **Technical information**

- For system width 50 mm.
- One-side adhesive.
- Delivery in 25 bars each with a length of 2 m.
- Assembly in combination with exterior gasket 3 to 5 mm.

| Article | Material | Surface | No. | PU |
|---------------------------|--------------|---------|---------------|------|
| Insulating block PH 50/29 | polyethylene | - | 168513 | 50 m |

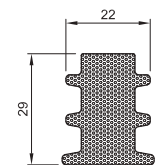

■ **Technical information**

- For system width 50 mm.
- One-side adhesive.
- Pasted aluminium foil on the inside.
- Delivery in 25 bars each with a length of 2 m.
- Assembly in combination with exterior gasket 3 to 5 mm.

| Article | Material | Surface | No. | PU |
|--------------------------|--------------|---------|---------------|------|
| Insulating block P 50/39 | polyethylene | - | 168514 | 50 m |

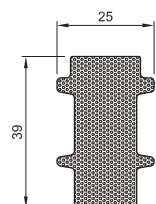

■ **Technical information**

- For system width 50 mm.
- One-side adhesive.
- Delivery in 25 bars each with a length of 2 m.
- Assembly in combination with exterior gasket 3 to 5 mm.

| Article | Material | Surface | No. | PU |
|--------------------------|--------------|---------|---------------|------|
| Insulating block P 56/19 | polyethylene | - | 168515 | 50 m |

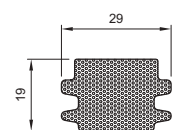

■ **Technical information**

- For system width 56 mm.
- One-side adhesive.
- Delivery in 25 bars each with a length of 2 m.
- Assembly in combination with exterior gasket 3 to 5 mm.

System width 50/56/76 mm
Insulating blocks
I-Series/V-Series

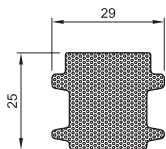

| Article | Material | Surface | No. | PU |
|--------------------------|--------------|---------|---------------|------|
| Insulating block P 56/25 | polyethylene | - | 168516 | 50 m |

■ **Technical information**

- For system width 56 mm.
- One-side adhesive.
- Delivery in 25 bars each with a length of 2 m.
- Assembly in combination with exterior gasket 3 to 5 mm.

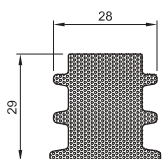

| Article | Material | Surface | No. | PU |
|---------------------------|--------------|---------|---------------|------|
| Insulating block PH 56/29 | polyethylene | - | 168519 | 50 m |

■ **Technical information**

- For system width 56 mm.
- One-side adhesive.
- Pasted aluminium foil on the inside.
- Delivery in 25 bars each with a length of 2 m.
- Assembly in combination with exterior gasket 3 to 5 mm.

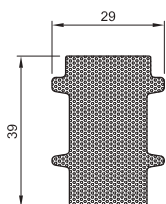

| Article | Material | Surface | No. | PU |
|--------------------------|--------------|---------|---------------|------|
| Insulating block P 56/39 | polyethylene | - | 168520 | 50 m |

■ **Technical information**

- For system width 56 mm.
- One-side adhesive.
- Delivery in 25 bars each with a length of 2 m.
- Assembly in combination with exterior gasket 3 to 5 mm.

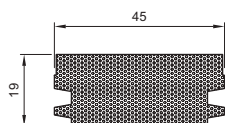

| Article | Material | Surface | No. | PU |
|--------------------------|--------------|---------|---------------|------|
| Insulating block P 76/19 | polyethylene | - | 168521 | 50 m |

■ **Technical information**

- For system width 76 mm.
- One-side adhesive.
- Delivery in 25 bars each with a length of 2 m.
- Assembly in combination with exterior gasket 3 to 5 mm.

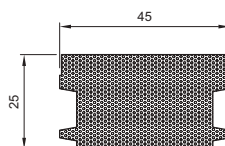

| Article | Material | Surface | No. | PU |
|--------------------------|--------------|---------|---------------|------|
| Insulating block P 76/25 | polyethylene | - | 168522 | 50 m |

■ **Technical information**

- For system width 76 mm.
- One-side adhesive.
- Delivery in 25 bars each with a length of 2 m.
- Assembly in combination with exterior gasket 3 to 5 mm.

System width 50/56/76 mm
Insulating blocks
I-Series/V-Series

| Article | Material | Surface | No. | PU |
|--------------------------|--------------|---------|---------------|------|
| Insulating block P 76/39 | polyethylene | - | 168526 | 50 m |

■ **Technical information**

- For system width 76 mm.
- One-side adhesive.
- Glass bite 23 mm.
- Delivery in 25 bars each with a length of 2 m.
- Assembly in combination with exterior gasket 5 mm.

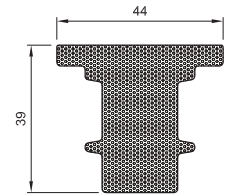

| Article | height mm | Material | Surface | No. | PU |
|---------------------------|-----------|--------------|---------|---------------|------|
| Insulating block SG 25/5 | 5 | polyethylene | - | 168541 | 50 m |
| Insulating block SG 25/8 | 8 | polyethylene | - | 168544 | 50 m |
| Insulating block SG 25/10 | 10 | polyethylene | - | 168546 | 50 m |
| Insulating block SG 25/12 | 12 | polyethylene | - | 168548 | 50 m |
| Insulating block SG 25/14 | 14 | polyethylene | - | 168550 | 50 m |
| Insulating block SG 25/16 | 16 | polyethylene | - | 168552 | 50 m |
| Insulating block SG 25/18 | 18 | polyethylene | - | 168554 | 50 m |
| Insulating block SG 25/20 | 20 | polyethylene | - | 168556 | 50 m |
| Insulating block SG 25/22 | 22 | polyethylene | - | 168558 | 50 m |
| Insulating block SG 25/24 | 24 | polyethylene | - | 168560 | 50 m |
| Insulating block SG 25/26 | 26 | polyethylene | - | 168562 | 50 m |
| Insulating block SG 25/28 | 28 | polyethylene | - | 168564 | 50 m |
| Insulating block SG 25/30 | 30 | polyethylene | - | 168566 | 50 m |
| Insulating block SG 25/32 | 32 | polyethylene | - | 168568 | 50 m |
| Insulating block SG 25/34 | 34 | polyethylene | - | 168570 | 50 m |
| Insulating block SG 25/36 | 36 | polyethylene | - | 168572 | 50 m |

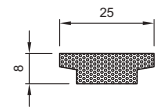

■ **Technical information**

- For glazing system SG2.
- One-side adhesive (side of interior gasket).
- Delivery in 25 bars each with a length of 2 m.

System width 50/56/76 mm
Insulating blocks
I-Series/V-Series

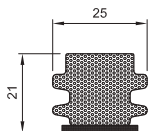

|  | Article | Material | Surface | No. | PU |
|---|-----------------------------|--------------|---------|---------------|------|
| | Fire protection block 50/21 | polyethylene | - | 168640 | 50 m |
| | Fire protection block 50/27 | polyethylene | - | 168642 | 50 m |
| | Fire protection block 50/41 | polyethylene | - | 168644 | 50 m |

■ **Technical information**

- For system width 50 mm.
- For fire resistant curtain walls.
- Adhesive on one side.
- Delivery in 25 bars each with a length of 2 m.
- Assembly in combination with no. 011070, 011073 or no. 011077.

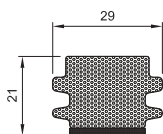

|  | Article | Material | Surface | No. | PU |
|---|-----------------------------|--------------|---------|---------------|------|
| | Fire protection block 56/21 | polyethylene | - | 168646 | 50 m |
| | Fire protection block 56/27 | polyethylene | - | 168648 | 50 m |
| | Fire protection block 56/41 | polyethylene | - | 168650 | 50 m |

■ **Technical information**

- For system width 56 mm.
- For fire resistant curtain walls.
- Adhesive on one side.
- Delivery in 25 bars each with a length of 2 m.
- Assembly in combination with no. 011070, 011073 or no. 011077.

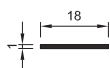

|  | Article | Material | Surface | No. | PU |
|---|---------------------------|-------------------|-----------------|---------------|------|
| | Fire protection tape 18/1 | Swelling material | black, adhesive | 167060 | 25 m |

■ **Technical information**

- Adhesive on one side.

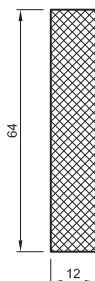

|  | Article | Material | Surface | No. | PU |
|---|---------------------------------|----------|---------|---------------|------|
| | Fire protection insertion 64/12 | Silicate | white | 119805 | 24 m |

■ **Technical information**

- Insertion for THERM⁺ A-V (not in roof area).
- For fire resistant curtain walls.

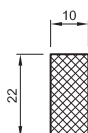

|  | Article | Material | Surface | No. | PU |
|---|---------------------------------|----------|---------|---------------|-----------|
| | Fire protection insertion 22/10 | Silicate | white | 119810 | 100 pc(s) |

■ **Technical information**

- Insertion for THERM⁺ A-V (not in roof area).
- For fire resistant curtain walls.
- For T-connector 100 to 200.

System width 50/56/76 mm
Insulating blocks
I-Series/V-Series

| Article | Material | Surface | No. | PU |
|--|----------|---------|---------------|----------|
| Fire protection insertion 22/10 with groove | Silicate | white | 119812 | 50 pc(s) |

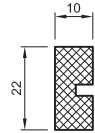

■ **Technical information**

- Insertion for THERM⁺ A-V (not in roof area).
- For fire resistant curtain walls.
- For T-connector 75.

| Article | Material | Surface | No. | PU |
|---------------------------|----------|---------|---------------|------|
| Fire protection insertion | Silicate | white | 168990 | 12 m |

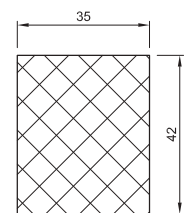

■ **Technical information**

- For fire resistant curtain walls.
- Assembly with fire protection insertion profile no. 119305.