

## ■ Integration elements

THERM <sup>+</sup> 50 S-I with FRAME <sup>+</sup> 75 WB	541
THERM <sup>+</sup> 50 S-I with FRAME <sup>+</sup> 75 WA	542
THERM <sup>+</sup> 50 S-I with FRAME <sup>+</sup> 90 WB	543
THERM <sup>+</sup> 50 S-I with WING 50 SK	544
THERM <sup>+</sup> 50 S-I with WING 50 A	545
THERM <sup>+</sup> 50 S-I with FRAME <sup>+</sup> 75 DI	546
THERM <sup>+</sup> 50 FS-I with FRAME <sup>+</sup> 75 WB	547
THERM <sup>+</sup> 50 FS-I with FRAME <sup>+</sup> 75 WA	548
THERM <sup>+</sup> 50 FS-I with FRAME <sup>+</sup> 90 WB	549
THERM <sup>+</sup> 50 FS-I with WING 50 SK	550
THERM <sup>+</sup> 50 FS-I with WING 50 A	551
THERM <sup>+</sup> 50 FS-I with FRAME <sup>+</sup> 75 DI	552



Steel façade

**THERM<sup>+</sup> 50 S-I with FRAME<sup>+</sup> 75 WB with frame 26/50/21**  
Mullion section hinge side - turn-tilt sash

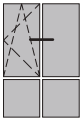

■ Profiles

Article	No.	PU
Integration outer frame 26/50/21	<b>207666</b>	6 m
Casement sash profile 51/35	<b>214902</b>	6 m
Exterior glazing bead	<b>218500</b>	6 m
Driving rod 20	<b>225530</b>	6 m

■ Gaskets

Article	No.	PU
Exterior glazing gasket	<b>220300</b>	100 m
Interior gasket 11	<b>220324</b>	75 m
Stop gasket 7	<b>220339</b>	200 m
Medial gasket	<b>220613</b>	50 m
Compensation gasket 2	<b>227010</b>	100 m

■ Accessories

Article	No.	PU
Assembly angle 50/6	<b>167606</b>	10 pc(s)

■ Technical information

- dimensions and article numbers may vary in the different system widths 56 and 76 mm
- selection tables and areas of application for assembly angles can be found in the corresponding **FRAME<sup>+</sup>** planning documents

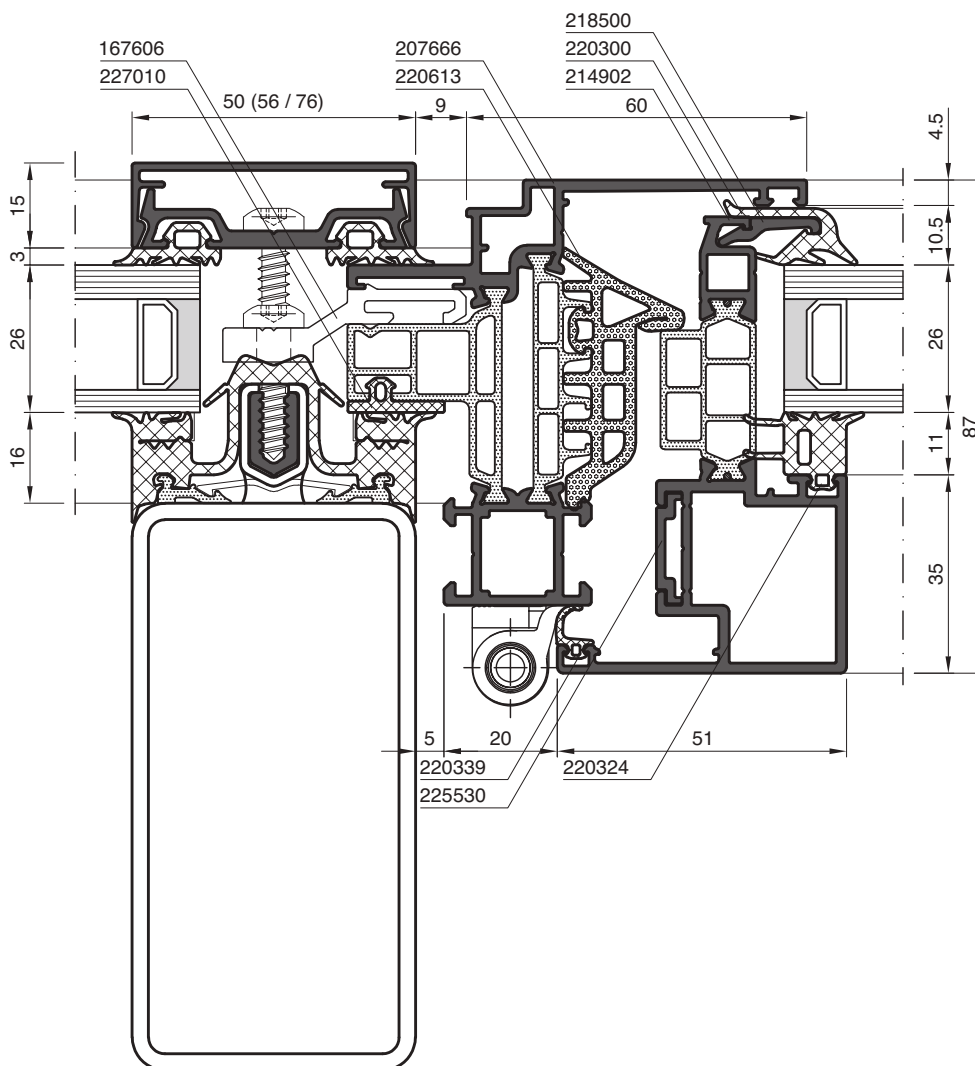

Steel façade

**THERM<sup>+</sup> 50 S-I with FRAME<sup>+</sup> 75 WA with frame 42/17**

Transom section head end - top-hung sash

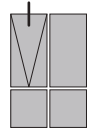

■ Profiles

Article	No.	PU
Integration outer frame 42/17	<b>217010</b>	6 m
Sash profile 45/92.5	<b>217015</b>	6 m
Glazing bead 22/47	<b>218447</b>	6 m
Driving rod 20	<b>225530</b>	6 m

■ Gaskets

Article	No.	PU
Rope 4	<b>220075</b>	100 pc(s)
Stop gasket	<b>220214</b>	200 m
Glazing gasket 5 to 6 F	<b>220405</b>	100 m
Exterior glazing gasket 4.5	<b>220550</b>	100 m
Exterior noise protection gasket	<b>220552</b>	100 m
Sealing frame vulcanised	<b>220615.R</b>	1 pc(s)
Sealing frame vulcanised	<b>220615.RT</b>	1 pc(s)
Compensation gasket 2	<b>227010</b>	100 m

■ Technical information

- dimensions and article numbers may vary in the different system widths 56 and 76 mm
- selection tables and areas of application for assembly angles can be found in the corresponding **FRAME<sup>+</sup>** planning documents

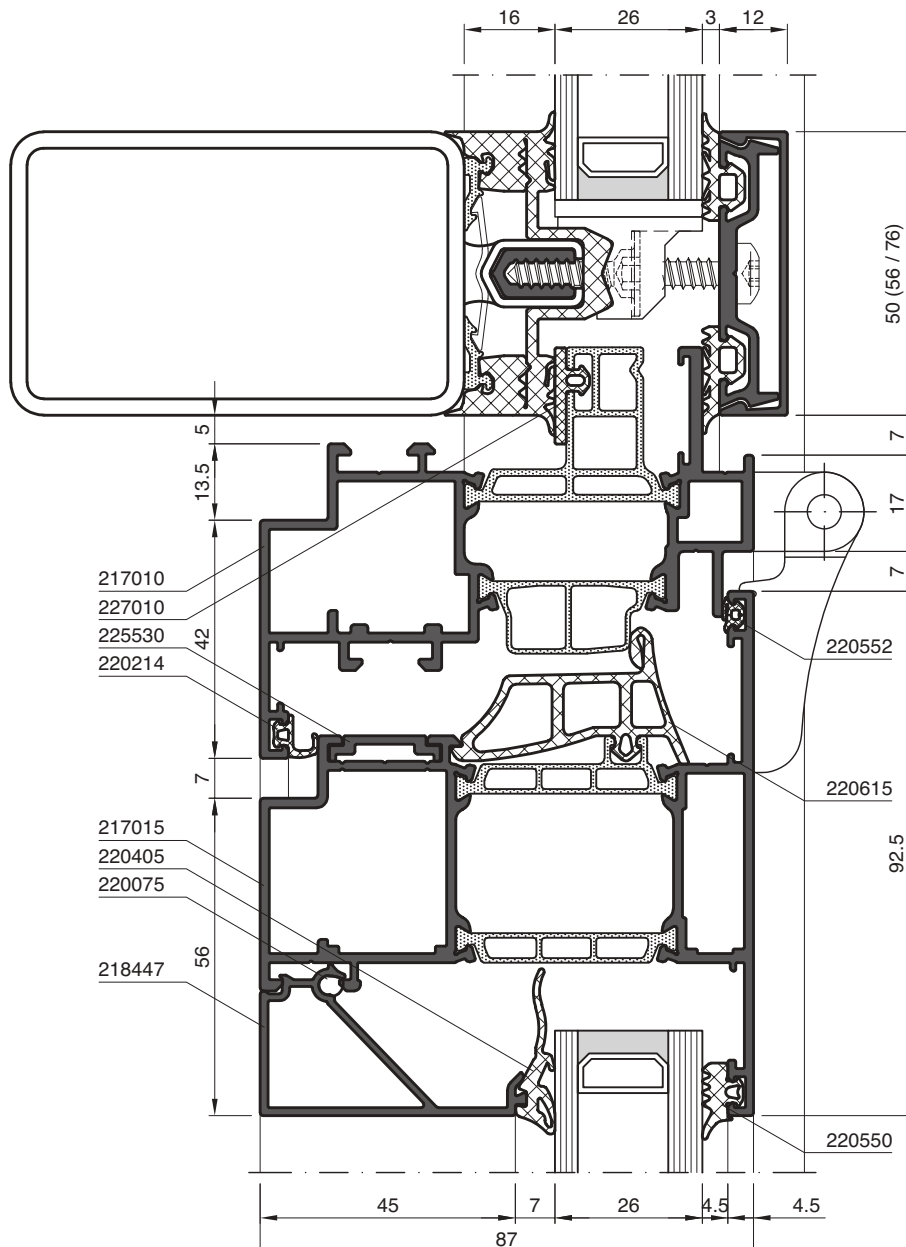

Steel façade

**THERM<sup>+</sup> 50 S-I with FRAME<sup>+</sup> 90 WB with frame 27/67**  
Transom section base point - turn-tilt sash

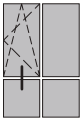

■ Profiles

Article	No.	PU
Integration outer frame 27/67	<b>215380</b>	6 m
Sash profile 65/34	<b>215390</b>	6 m
Glazing bead external	<b>218250</b>	6 m
Driving rod 20	<b>225530</b>	6 m

■ Technical information

- Dimensions and article numbers may vary in the different system widths 56 and 76 mm
- selection tables and areas of application for assembly angles can be found in the corresponding **FRAME<sup>+</sup>** planning documents

■ Gaskets

Article	No.	PU
Interior gasket 9	<b>220323</b>	100 m
Stop gasket 7	<b>220339</b>	200 m
Corner vulcanisation for exterior glazing gasket	<b>220650.R</b>	1 pc(s)
Corner vulcanisation for exterior glazing gasket	<b>220650.RT</b>	1 pc(s)
Corner vulcanisation for medial gasket	<b>220661.R</b>	1 pc(s)
Corner vulcanisation for medial gasket	<b>220661.RT</b>	1 pc(s)
Compensation gasket 4	<b>227015</b>	100 m

■ Accessories

Article	No.	PU
Glass carrier	<b>225025</b>	100 pc(s)
Insulation insertion 16/47	<b>227951</b>	50 m
Insulation insertion 20.5/41.5	<b>227966</b>	50 m

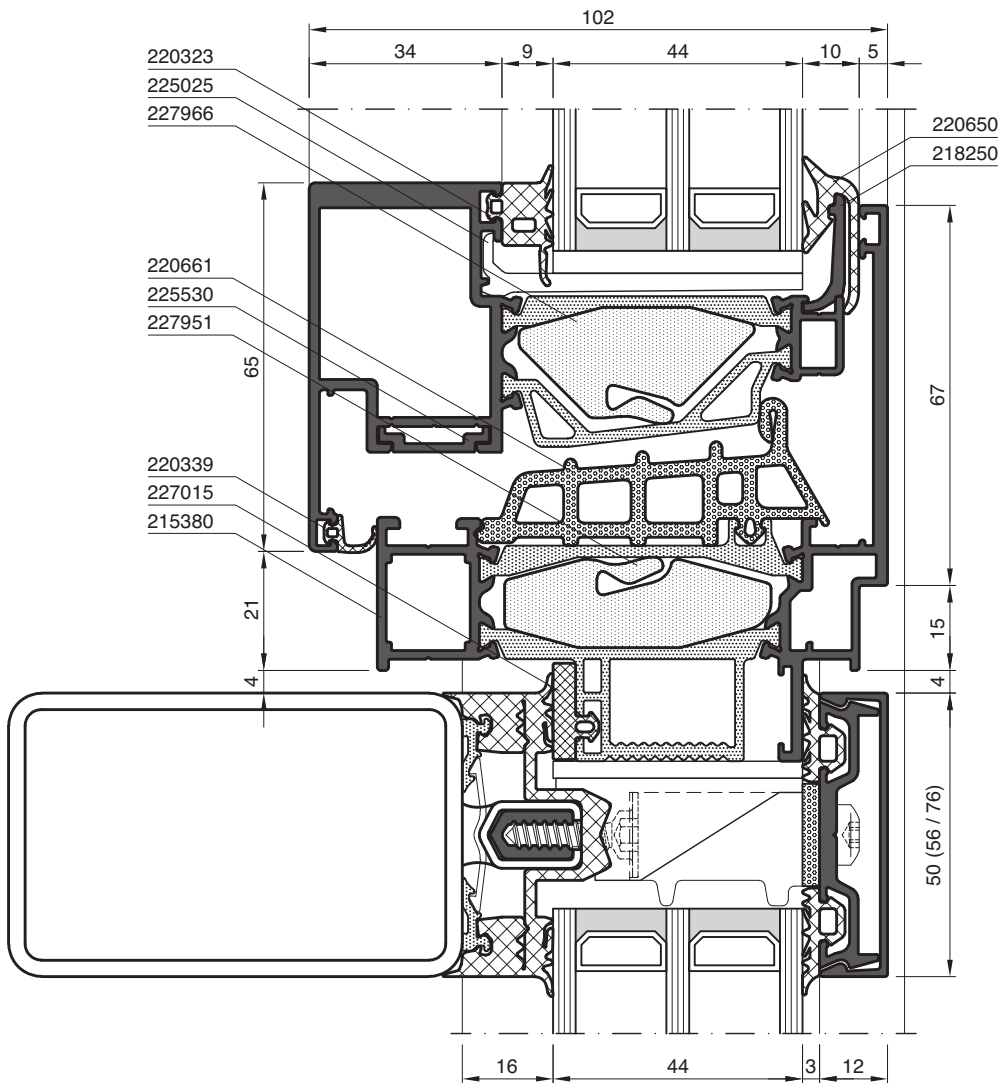

THERM<sup>+</sup> S-I/FS-I  
Integration elements

Steel façade  
**THERM<sup>+</sup> 50 S-I with WING 50 SK with stepped edge glazing**  
Transom section base point - top hung sash

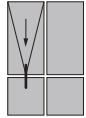

■ Profiles

Article	No.	PU
Interior sash profile 12/55 punched	<b>204000</b>	6 m
Exterior sash profile	<b>204110</b>	6 m
Outer frame 35/72	<b>205000</b>	6 m
Frame profile	<b>218040</b>	6 m
Glazing profile 6	<b>218082</b>	6 m

■ Technical information

- dimensions and article numbers may vary in the different system widths 56 and 76 mm
- selection tables and areas of application for assembly angles can be found in the corresponding **WING planning documents**

■ Gaskets

Article	No.	PU
Rope 3	<b>220065</b>	200 m
Interior glazing gasket 5 to 6	<b>220110</b>	100 m
Cover gasket	<b>220190</b>	100 m
Stop gasket	<b>220214</b>	200 m
Corner vulcanised medial gasket	<b>220226.R</b>	1 pc(s)
Corner vulcanised medial gasket	<b>220226.RT</b>	1 pc(s)

■ Accessories

Article	No.	PU
Driving rod 20	<b>225505</b>	1 pc(s)
Cylinder tapping screw ST4.8 x 19	<b>230070</b>	100 pc(s)
Special tapping screw ST3.9 x 13	<b>230075</b>	100 pc(s)

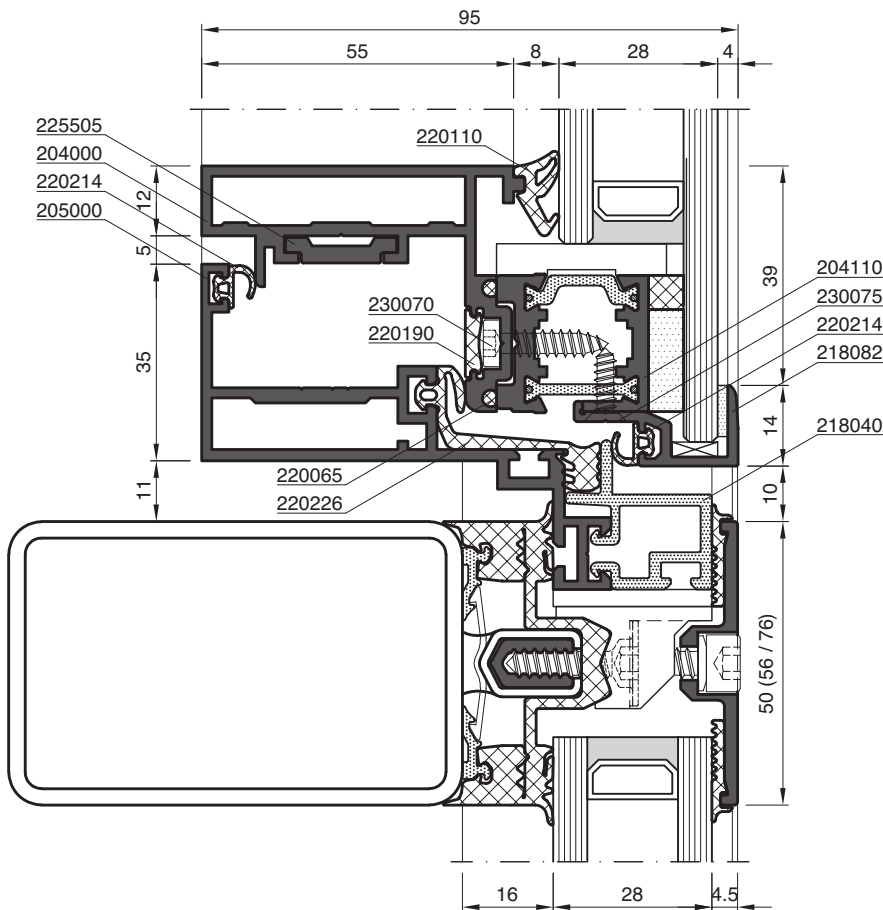

Steel façade

**THERM<sup>+</sup> 50 S-I with WING 50 A as bottom-hung sash**  
Transom section base point with hinge - bottom-hung sash

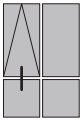

■ Profiles

Article	No.	PU
Interior sash profile 12/55 punched	<b>204000</b>	6 m
Exterior sash profile	<b>204100</b>	6 m
Outer frame 45/82/6	<b>205100</b>	6 m
Frame profile 18	<b>218041</b>	6 m

■ Technical information

- dimensions and article numbers may vary in the different system widths 56 and 76 mm
- for insert element WING 50 A as a bottom-hung sash, a transom or base gasket with flag must always be installed in the transom below the window
- selection tables and areas of application for assembly angles can be found in the corresponding **WING planning documents**

■ Gaskets

Article	No.	PU
Rope 3	<b>220065</b>	200 m
Interior glazing gasket 5 to 6	<b>220110</b>	100 m
Cover gasket	<b>220190</b>	100 m
Gasket for pressure profile 2/16	<b>220205</b>	100 m
Stop gasket	<b>220214</b>	200 m
Corner vulcanised medial gasket	<b>220226.R</b>	1 pc(s)
Corner vulcanised medial gasket	<b>220226.RT</b>	1 pc(s)

■ Accessories

Article	No.	PU
Driving rod 20	<b>225505</b>	1 pc(s)
Cylinder tapping screw ST4.8 x 19	<b>230070</b>	100 pc(s)

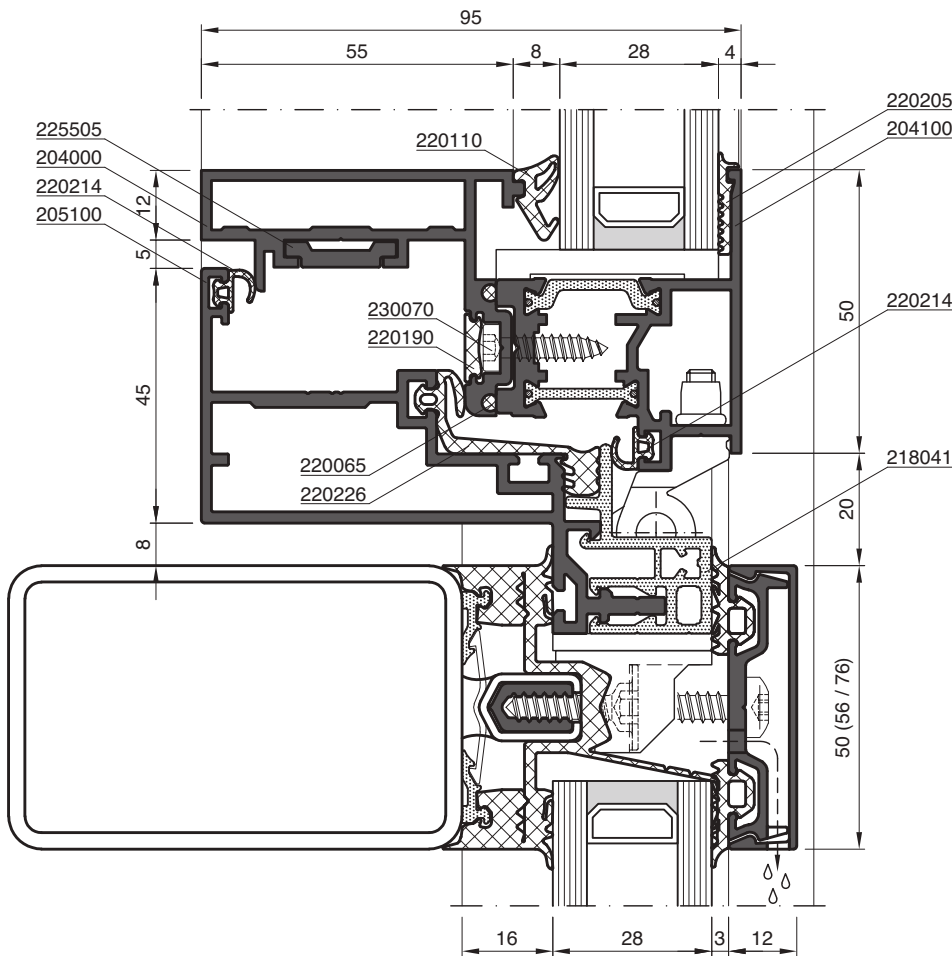

Steel façade  
**THERM<sup>+</sup> 50 S-I with FRAME<sup>+</sup> 75 DI with frame 44/65/21 Basic Style**  
Mullion section hinge side - door

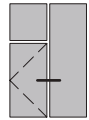

■ Profiles

Article	No.	PU
Glazing bead 22/47	<b>218447</b>	6 m
Integration outer frame 44/65/21	<b>314002</b>	6 m
Sash profile 84/71	<b>314100</b>	6.5 m

■ Technical information

- dimensions and article numbers may vary in the different system widths 56 and 76 mm
- selection tables and areas of application for assembly angles can be found in the corresponding **FRAME<sup>+</sup>** planning documents

■ Gaskets

Article	No.	PU
Rope 4	<b>220075</b>	100 pc(s)
Glazing gasket 5 to 6 F	<b>220405</b>	100 m
Exterior glazing gasket 4.5	<b>220550</b>	100 m
Compensation gasket 2	<b>227010</b>	100 m
Piping gasket	<b>320003</b>	200 m
Stop gasket 7	<b>320100</b>	200 m

■ Accessories

Article	No.	PU
Assembly angle 50/6	<b>167606</b>	10 pc(s)

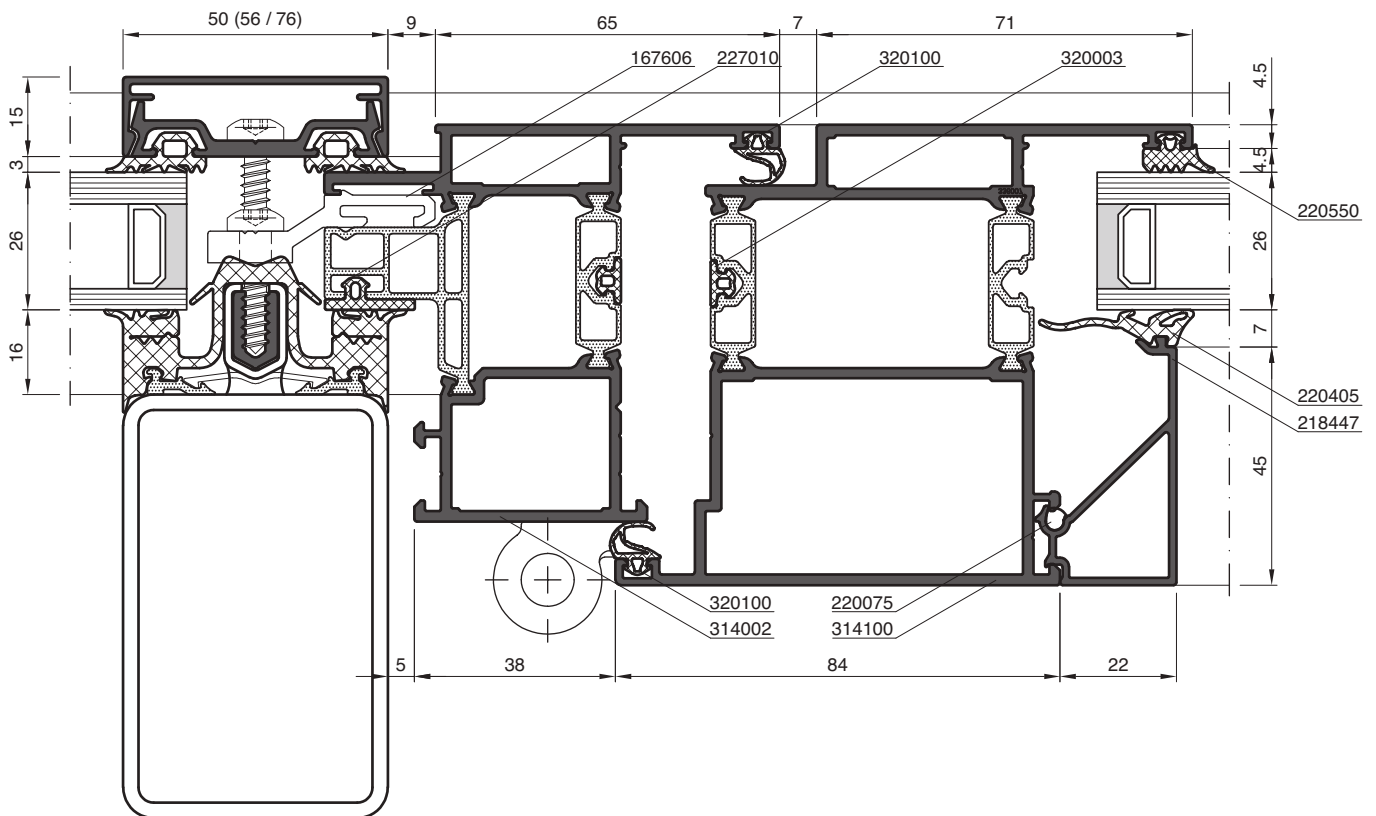



Steel façade

**THERM<sup>+</sup> 50 FS-I with FRAME<sup>+</sup> 75 WB with frame 26/50/21**  
Mullion section hinge side - turn-tilt sash

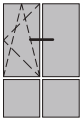

■ Profiles

Article	No.	PU
Integration outer frame 26/50/21	<b>207666</b>	6 m
Casement sash profile 51/35	<b>214902</b>	6 m
Exterior glazing bead	<b>218500</b>	6 m
Driving rod 20	<b>225530</b>	6 m

■ Technical information

- dimensions and article numbers may vary in system width 56 mm
- selection tables and areas of application for assembly angles can be found in the corresponding **FRAME<sup>+</sup>** planning documents

■ Gaskets

Article	No.	PU
Exterior glazing gasket	<b>220300</b>	100 m
Interior gasket 11	<b>220324</b>	75 m
Stop gasket 7	<b>220339</b>	200 m
Medial gasket	<b>220613</b>	50 m
Corner vulcanisation for medial gasket	<b>220613.R</b>	1 pc(s)
Corner vulcanisation for medial gasket	<b>220613.RT</b>	1 pc(s)
Compensation gasket 2	<b>227010</b>	100 m

■ Accessories

Article	No.	PU
Assembly angle 50/6	<b>167606</b>	10 pc(s)

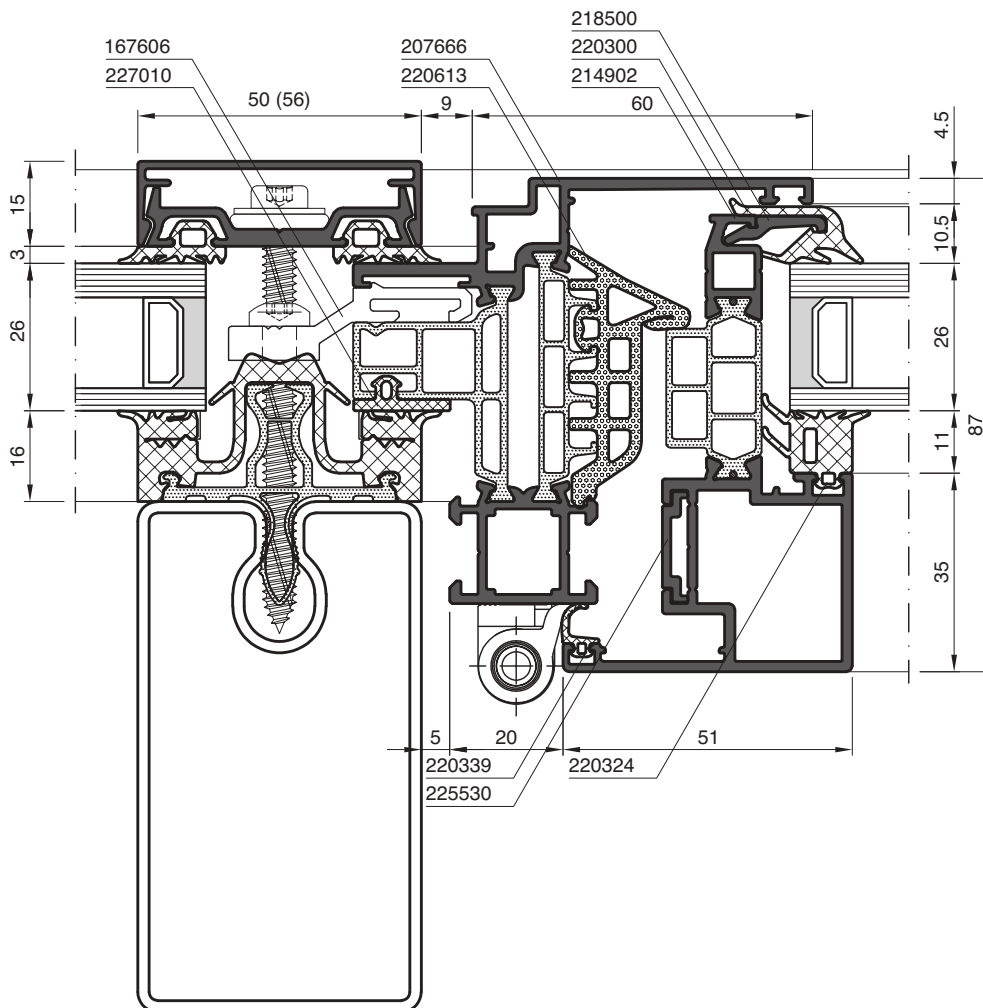

Steel façade

**THERM<sup>+</sup> 50 FS-I with FRAME<sup>+</sup> 75 WA with frame 42/17**

Transom section head end - top-hung sash

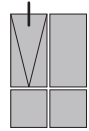

■ Profiles

Article	No.	PU
Integration outer frame 42/17	<b>217010</b>	6 m
Sash profile 45/92.5	<b>217015</b>	6 m
Glazing bead 22/47	<b>218447</b>	6 m
Driving rod 20	<b>225530</b>	6 m

■ Gaskets

Article	No.	PU
Rope 4	<b>220075</b>	100 pc(s)
Stop gasket	<b>220214</b>	200 m
Glazing gasket 5 to 6 F	<b>220405</b>	100 m
Exterior glazing gasket 4.5	<b>220550</b>	100 m
Exterior noise protection gasket	<b>220552</b>	100 m
Sealing frame vulcanised	<b>220615.R</b>	1 pc(s)
Sealing frame vulcanised	<b>220615.RT</b>	1 pc(s)
Compensation gasket 2	<b>227010</b>	100 m

■ Technical information

- dimensions and article numbers may vary in system width 56 mm
- selection tables and areas of application for assembly angles can be found in the corresponding **FRAME<sup>+</sup>** planning documents

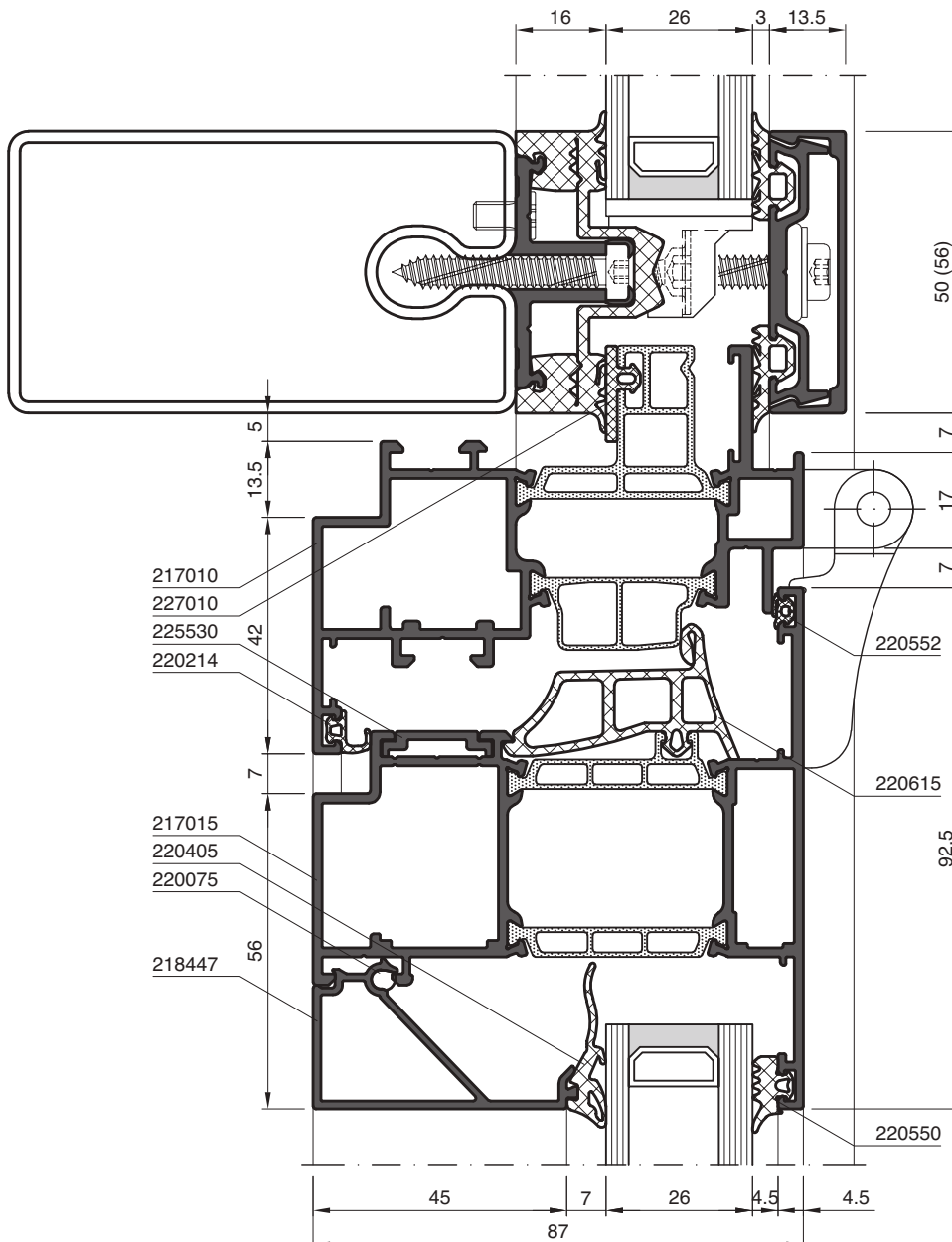

Steel façade

**THERM<sup>+</sup> 50 FS-I with FRAME<sup>+</sup> 90 WB with frame 27/67**  
Transom section base point - turn-tilt sash

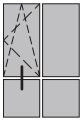

■ Profiles

Article	No.	PU
Integration outer frame 27/67	<b>215380</b>	6 m
Sash profile 65/34	<b>215390</b>	6 m
Glazing bead external	<b>218250</b>	6 m
Driving rod 20	<b>225530</b>	6 m

■ Technical information

- dimensions and article numbers may vary in system width 56 mm
- selection tables and areas of application for assembly angles can be found in the corresponding **FRAME<sup>+</sup> planning documents**

■ Gaskets

Article	No.	PU
Interior gasket 9	<b>220323</b>	100 m
Stop gasket 7	<b>220339</b>	200 m
Corner vulcanisation for exterior glazing gasket	<b>220650.R</b>	1 pc(s)
Corner vulcanisation for exterior glazing gasket	<b>220650.RT</b>	1 pc(s)
Corner vulcanisation for medial gasket	<b>220661.R</b>	1 pc(s)
Corner vulcanisation for medial gasket	<b>220661.RT</b>	1 pc(s)
Compensation gasket 4	<b>227015</b>	100 m

■ Accessories

Article	No.	PU
Glass carrier	<b>225025</b>	100 pc(s)
Insulation insertion 16/47	<b>227951</b>	50 m
Insulation insertion 20.5/41.5	<b>227966</b>	50 m

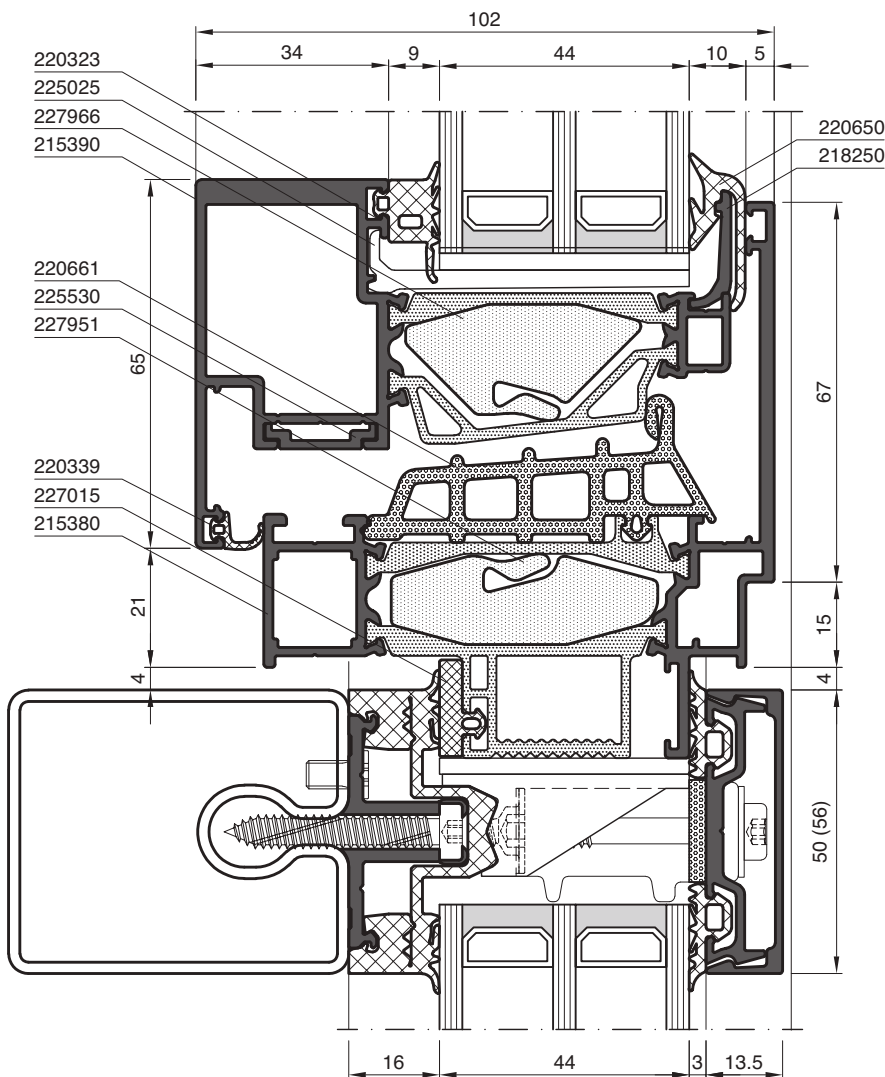

Steel façade

**THERM<sup>+</sup> 50 FS-I with WING 50 SK with stepped edge glazing**

Transom section base point - top hung sash

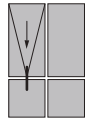

■ Profiles

Article	No.	PU
Interior sash profile 12/55 punched	<b>204000</b>	6 m
Exterior sash profile	<b>204110</b>	6 m
Outer frame 35/72	<b>205000</b>	6 m
Frame profile	<b>218040</b>	6 m
Glazing profile 6	<b>218082</b>	6 m

■ Gaskets

Article	No.	PU
Rope 3	<b>220065</b>	200 m
Interior glazing gasket 5 to 6	<b>220110</b>	100 m
Cover gasket	<b>220190</b>	100 m
Stop gasket	<b>220214</b>	200 m
Corner vulcanised medial gasket	<b>220226.R</b>	1 pc(s)
Corner vulcanised medial gasket	<b>220226.RT</b>	1 pc(s)

■ Accessories

Article	No.	PU
Driving rod 20	<b>225505</b>	1 pc(s)
Cylinder tapping screw ST4.8 x 19	<b>230070</b>	100 pc(s)
Special tapping screw ST3.9 x 13	<b>230075</b>	100 pc(s)

■ Technical information

- dimensions and article numbers may vary in system width 56 mm
- selection tables and areas of application for assembly angles can be found in the corresponding **WING** planning documents

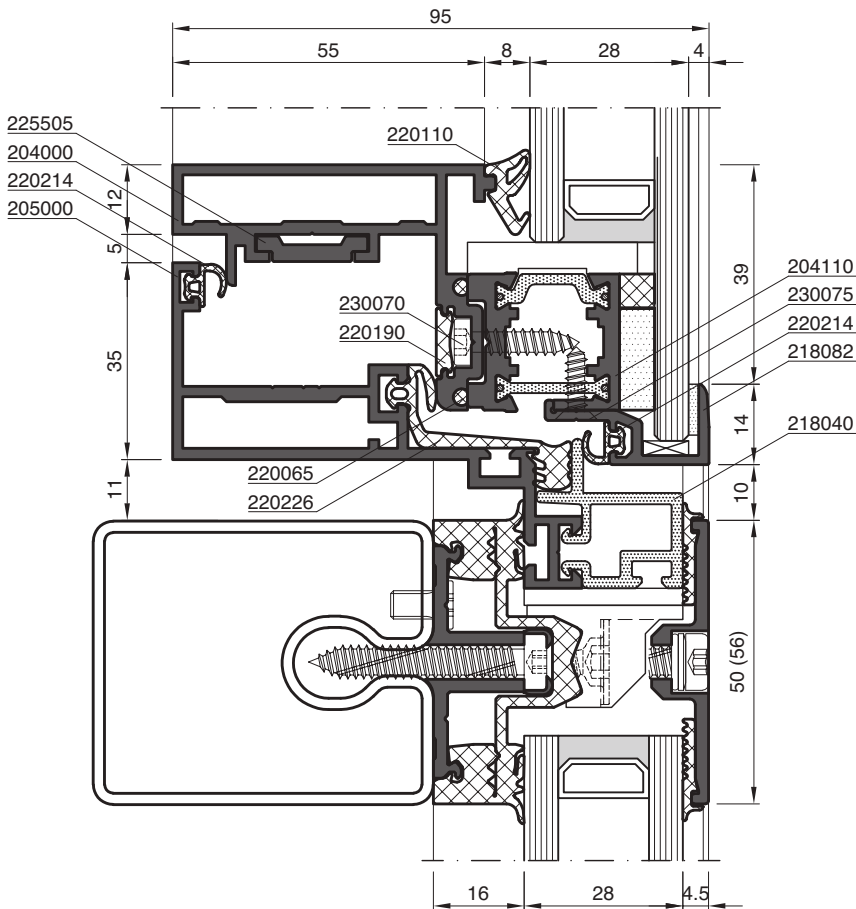

Steel façade

**THERM<sup>+</sup> 50 FS-I with WING 50 A as bottom-hung sash**  
Transom section base point with hinge - bottom-hung sash

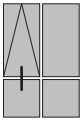

■ Profiles

Article	No.	PU
Interior sash profile 12/55 punched	<b>204000</b>	6 m
Exterior sash profile	<b>204100</b>	6 m
Outer frame 45/82/6	<b>205100</b>	6 m
Frame profile 18	<b>218041</b>	6 m

■ Technical information

- dimensions and article numbers may vary in the different system widths 56 mm
- for insert element WING 50 A as a bottom-hung sash, a transom or base gasket with flag must always be installed in the transom below the window
- selection tables and areas of application for assembly angles can be found in the corresponding **WING** planning documents

■ Gaskets

Article	No.	PU
Rope 3	<b>220065</b>	200 m
Interior glazing gasket 5 to 6	<b>220110</b>	100 m
Cover gasket	<b>220190</b>	100 m
Gasket for pressure profile 2/16	<b>220205</b>	100 m
Stop gasket	<b>220214</b>	200 m
Corner vulcanised medial gasket	<b>220226.R</b>	1 pc(s)
Corner vulcanised medial gasket	<b>220226.RT</b>	1 pc(s)

■ Accessories

Article	No.	PU
Driving rod 20	<b>225505</b>	1 pc(s)
Cylinder tapping screw ST4.8 x 19	<b>230070</b>	100 pc(s)

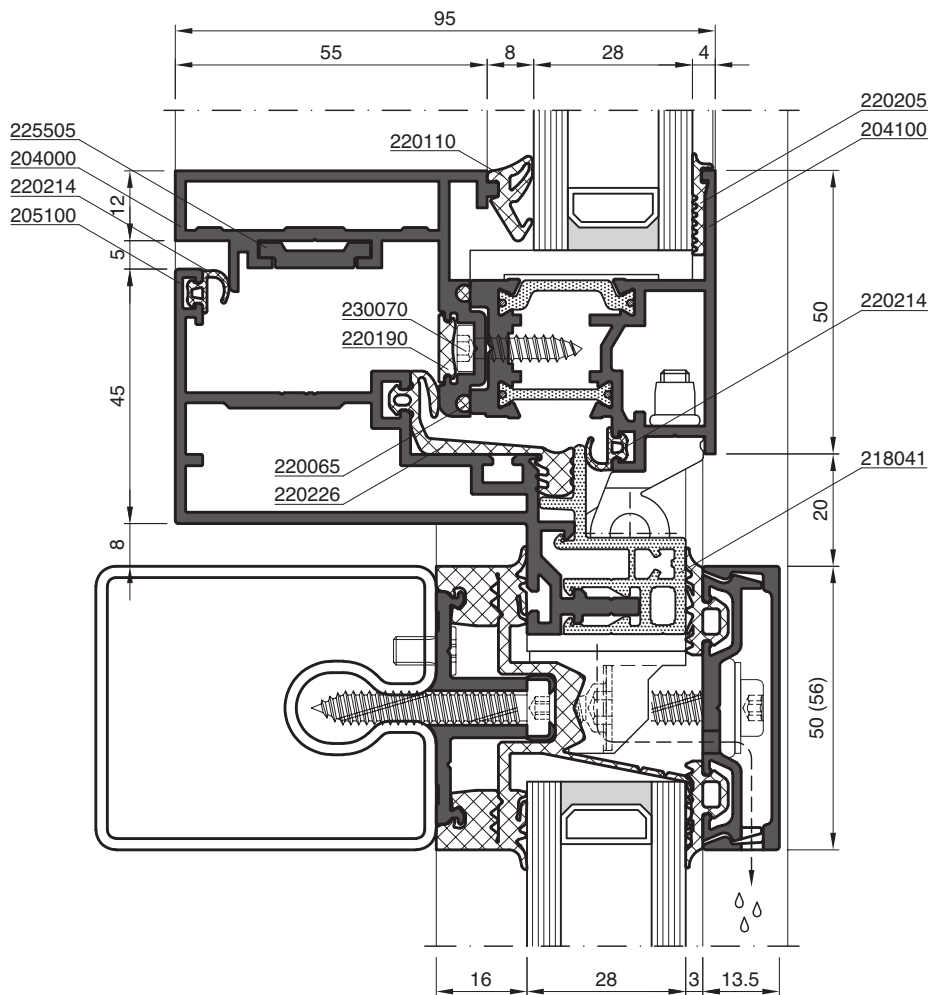

Steel façade

**THERM<sup>+</sup> 50 FS-I with FRAME<sup>+</sup> 75 DI with frame 44/65/21 Basic Style**

Mullion section hinge side - door

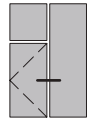

■ Profiles

Article	No.	PU
Glazing bead 22/47	<b>218447</b>	6 m
Integration outer frame 44/65/21	<b>314002</b>	6 m
Sash profile 84/71	<b>314100</b>	6.5 m

■ Technical information

- dimensions and article numbers may vary in system width 56 mm
- selection tables and areas of application for assembly angles can be found in the corresponding **FRAME<sup>+</sup>** planning documents

■ Gaskets

Article	No.	PU
Rope 4	<b>220075</b>	100 pc(s)
Glazing gasket 5 to 6 F	<b>220405</b>	100 m
Exterior glazing gasket 4.5	<b>220550</b>	100 m
Compensation gasket 2	<b>227010</b>	100 m
Piping gasket	<b>320003</b>	200 m
Stop gasket 7	<b>320100</b>	200 m

■ Accessories

Article	No.	PU
Assembly angle 50/6	<b>167606</b>	10 pc(s)

