

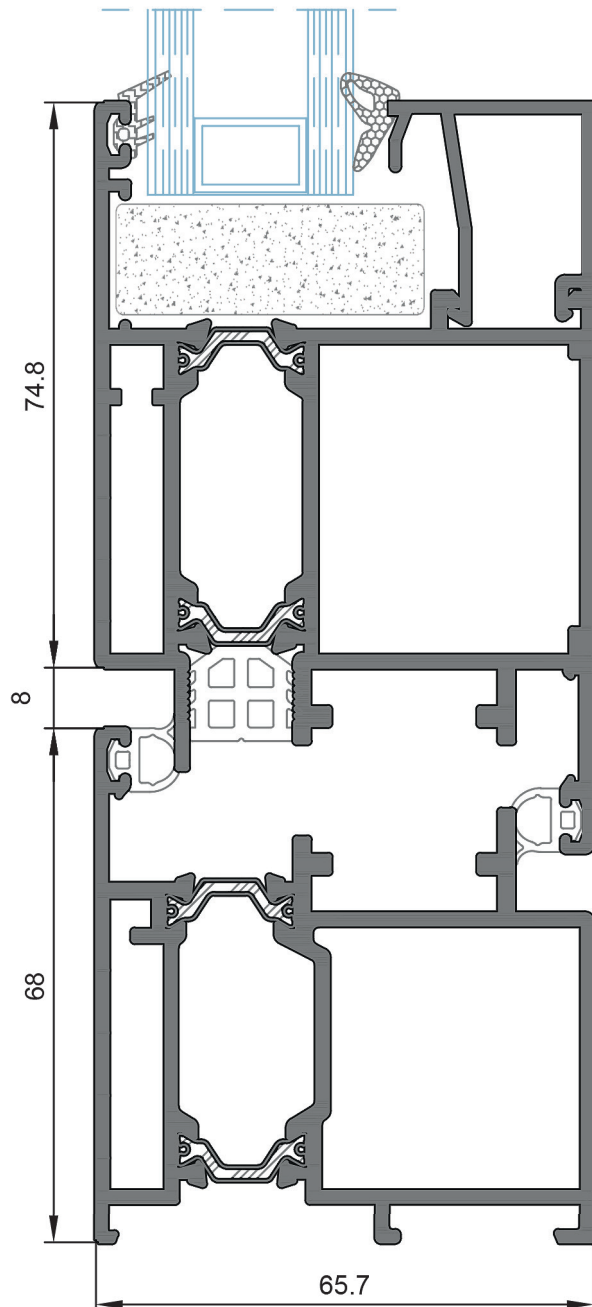

Alumarte

SERIE PLATINIUM 66

La Serie Platinum 66 es un sistema de Puerta Coplanar de líneas rectas con Rotura Puente térmico, ideada para un Alto tránsito con posibilidad de Apertura Interior y Exterior. El diseño de la serie ofrece una línea visual muy atractiva, y una particularidad de la serie es que el nudo Central es reducido y compacto. Se integra a la perfección con las series de correderas 870RT, 880RT Hermetic y el sistema abatible 24000RT. Sistema válido en su versión de 1 y 2 Hojas de Apertura Exterior para salidas Antipánico y de Emergencia según normativa EN1125 y EN179. Resistencia a aperturas y cierres repetidos (UNE-EN 1191-2000) para 1.000.000 de ciclos. Posibilidad de incorporar Bisagras Ocultas y Cierrapuertas Oculto.



EFICIENCIA ENERGÉTICA

U_w desde 1 (W/m²K)

Consultar tipología, dimensiones y vidrio.

ACRISTALAMIENTO

Acristalamiento de hasta 43mm con juntas de goma a ambos lados

PESO

Peso Máximo de Hoja de hasta 220kg

CATEGORÍAS ALCANZADAS EN BANCOS DE ENSAYO

Permeabilidad al aire

(UNE-EN 12207): Clase 4

Estanqueidad al agua

(UNE-EN 12208): Clase 6A

Resistencia al viento

(UNE-EN 12210): Clase C4

RESISTENCIA AL IMPACTO DE CUERPO BLANDO

Ensayo realizado según norma (UNE-EN 13049): Clase 5

ACABADOS

Lacado colores (Ral, moteados, rugosos, metalizados..), lacado imitación madera, anodizado, bicolors.



PUERTAS APERTURA INTERIOR

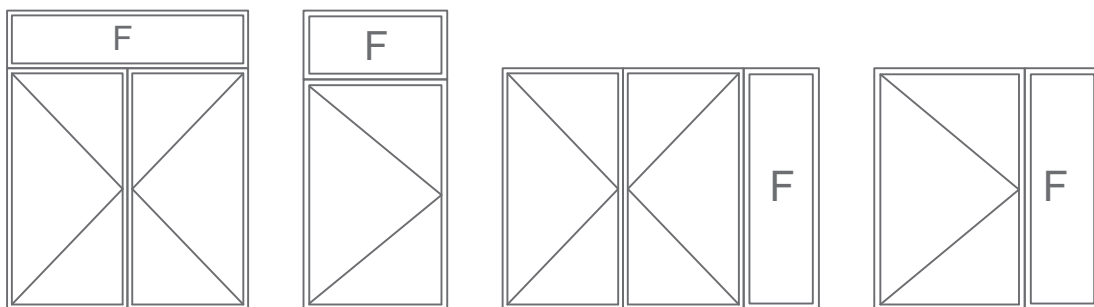
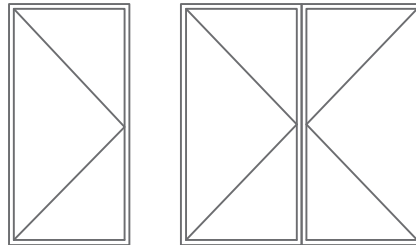

PUERTAS APERTURA EXTERIOR

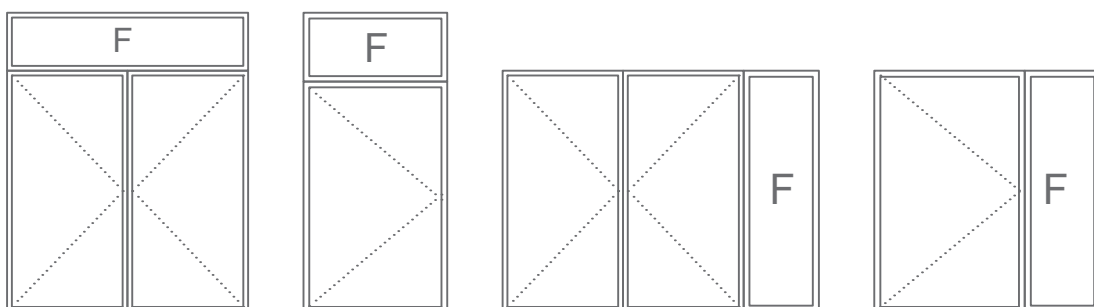
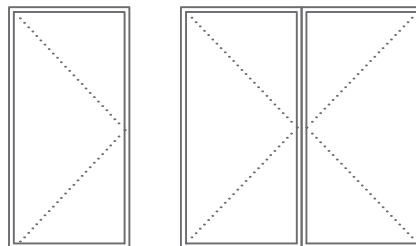

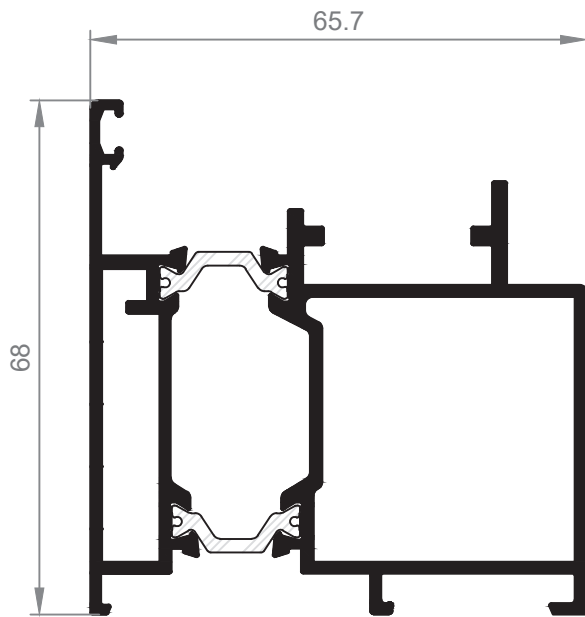

24621
Marco puerta

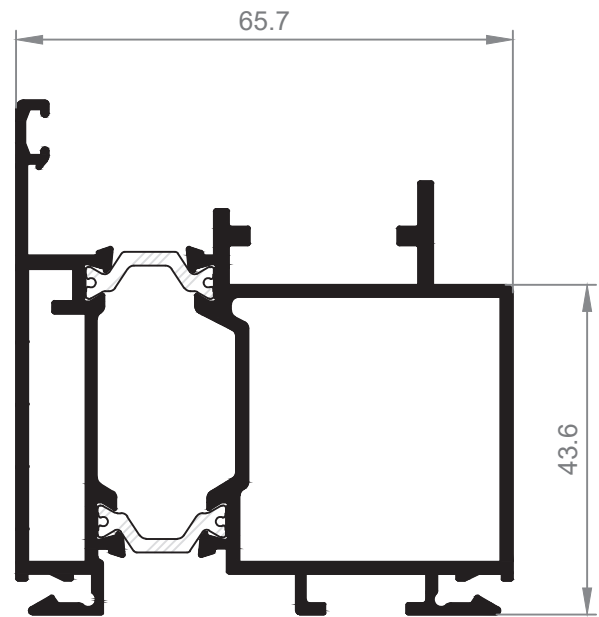

24661
Marco Clip puerta

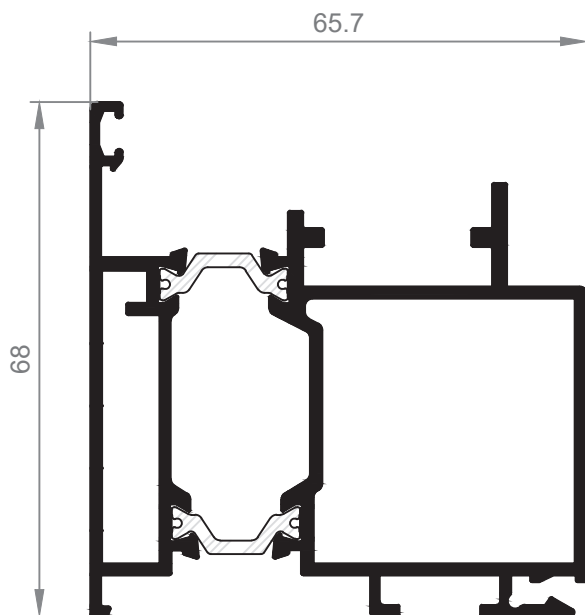

24671
Marco Clip Interior puerta

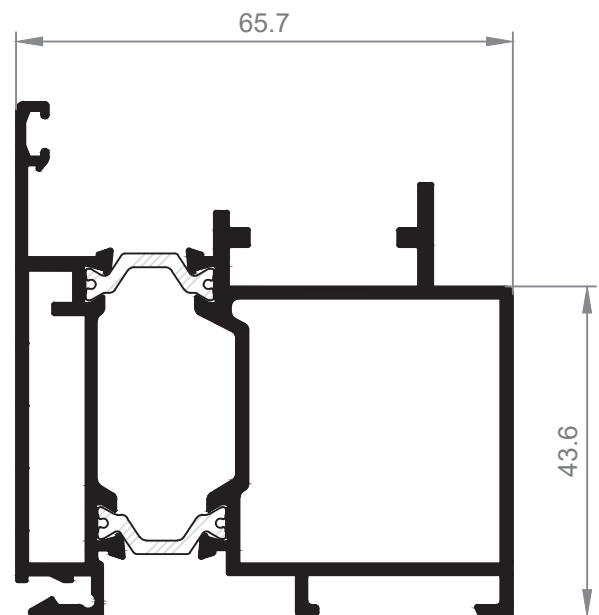

24681
Marco Clip Exterior puerta

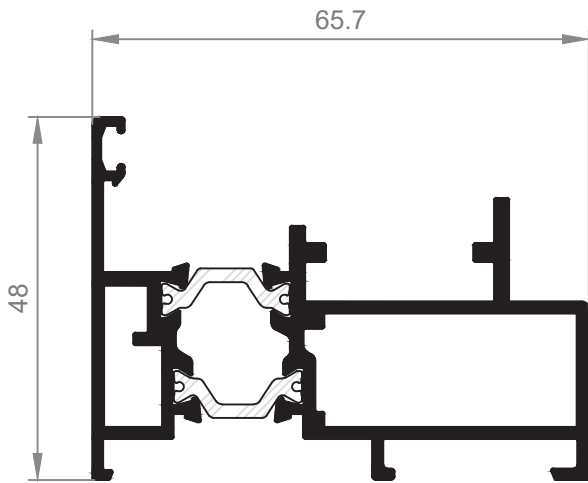

24601
Marco puerta reducido

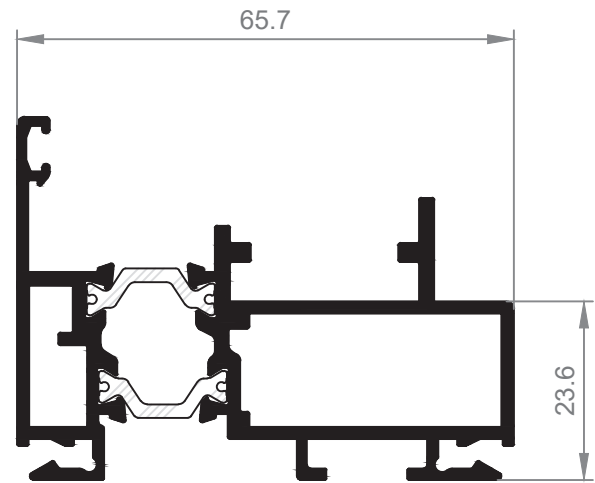

24631
Marco Clip puerta reducido

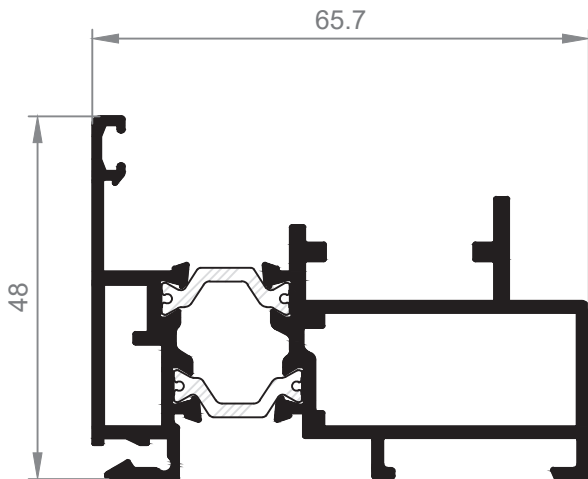

24641
Marco Clip Exterior puerta reducido

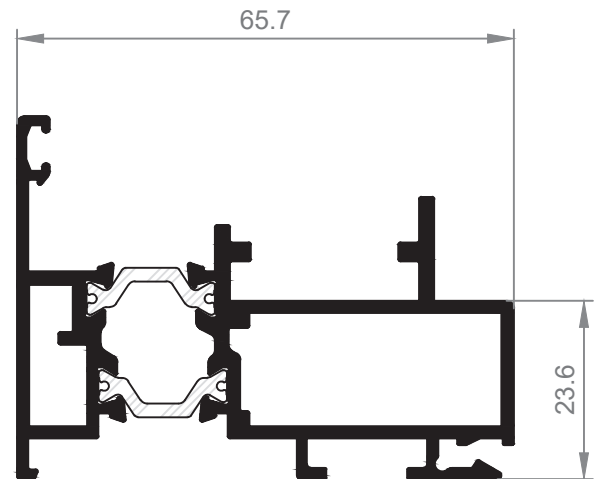

24651
Marco Clip Interior puerta reducido

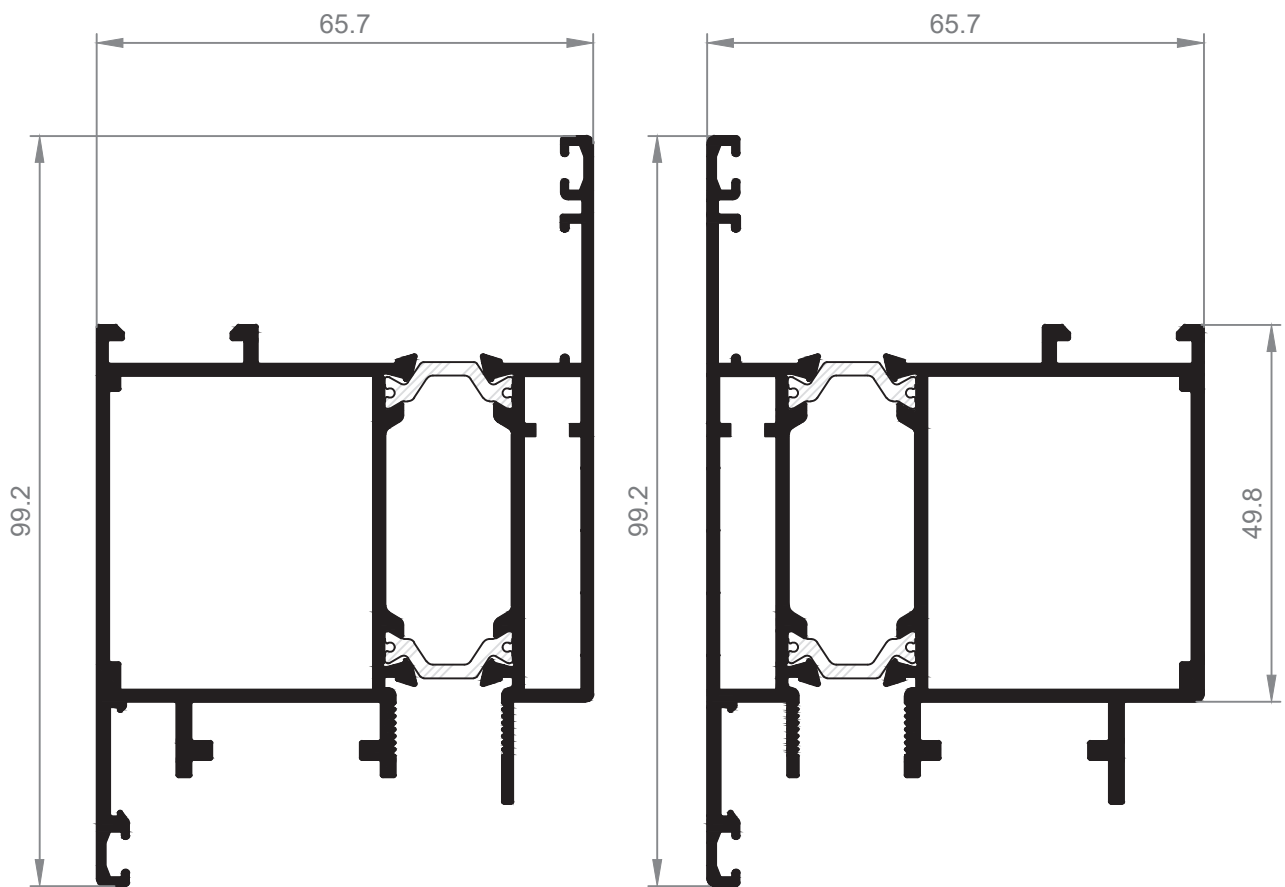

24622
Hoja "Z" Apertura Interior

24623
INVERSOR Apertura Interior 2 hojas
Suministro de material a 4500mm.

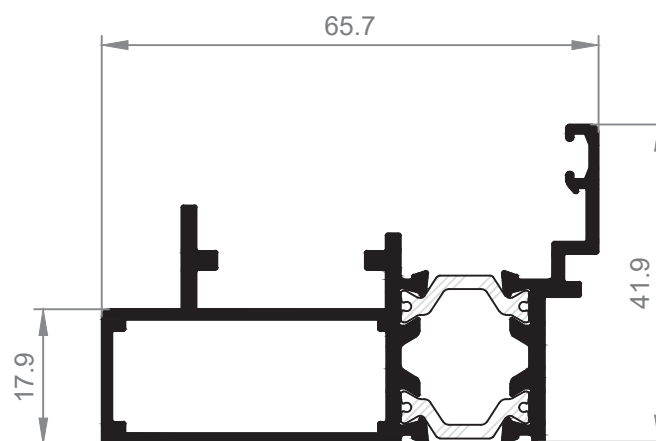

24640
Conversor Apertura Interior

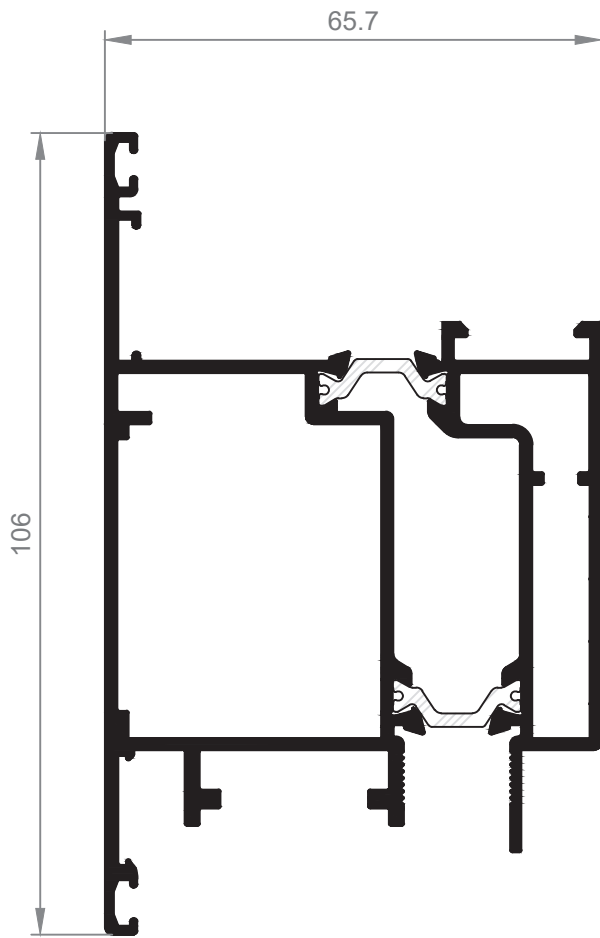

24628
Hoja "T" Apertura Exterior

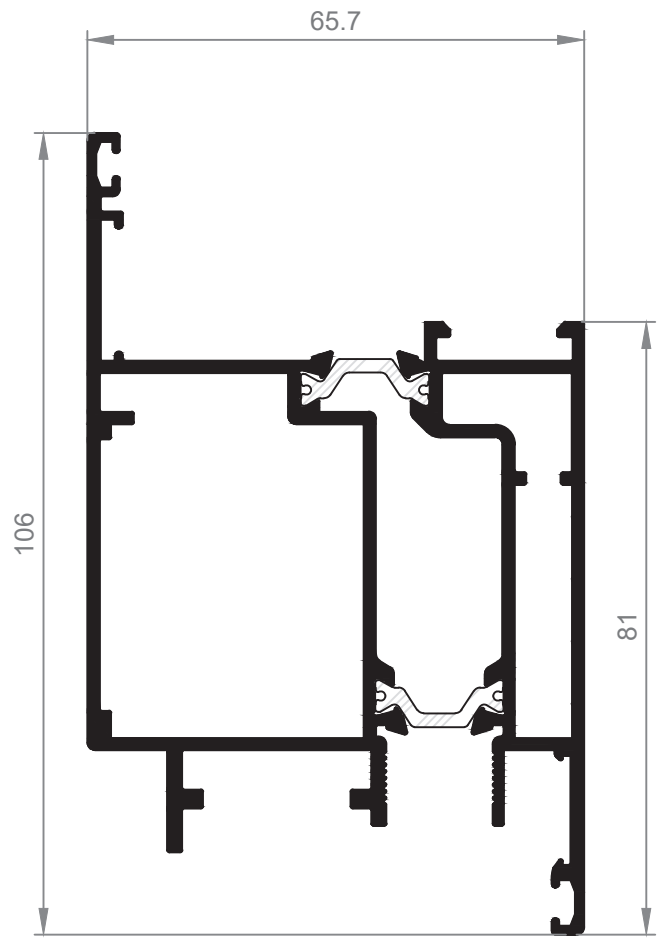

24629
INVERSOR Apertura Exterior 2 hojas
Suministro de material a 4500mm.

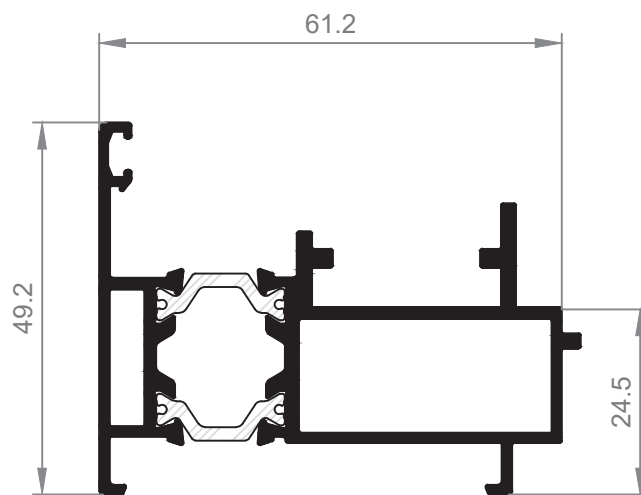

24650
Conversor Apertura Exterior

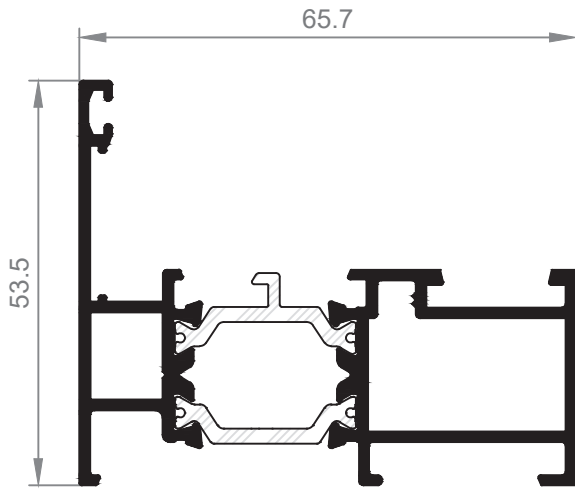

24001
Marco

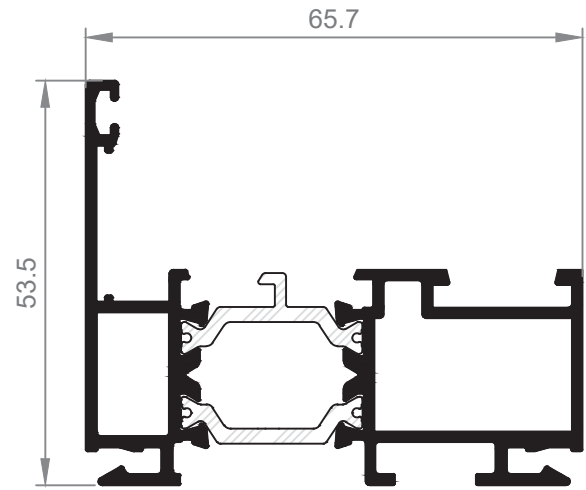

24101
Marco Clip Frontal

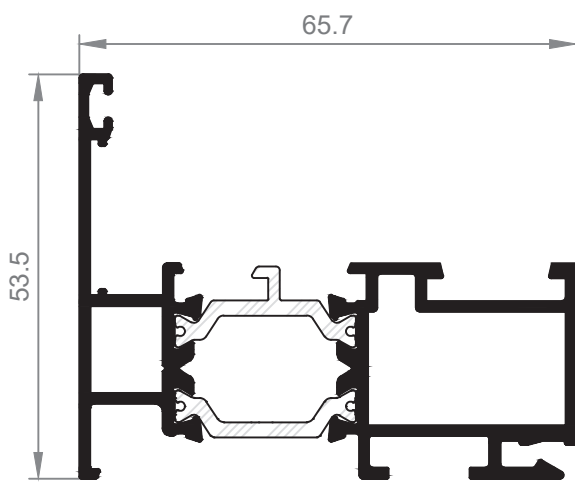

24201
Marco Clip Frontal Int.

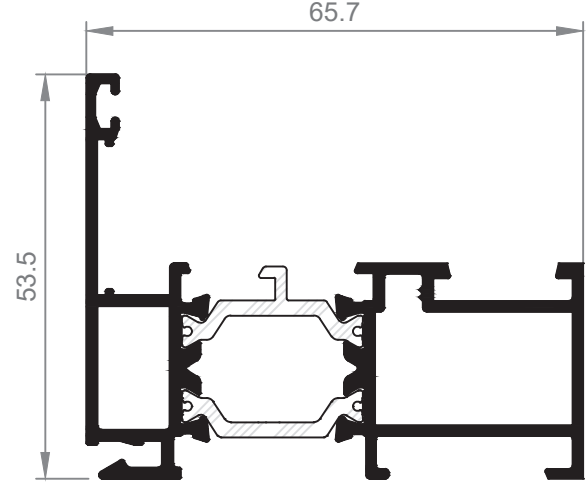

24401
Marco Clip Frontal Ext.

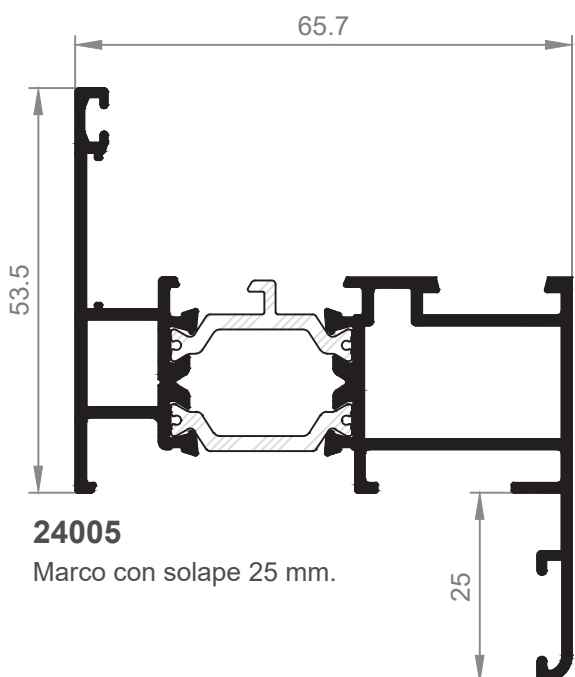

24005
Marco con solape 25 mm.

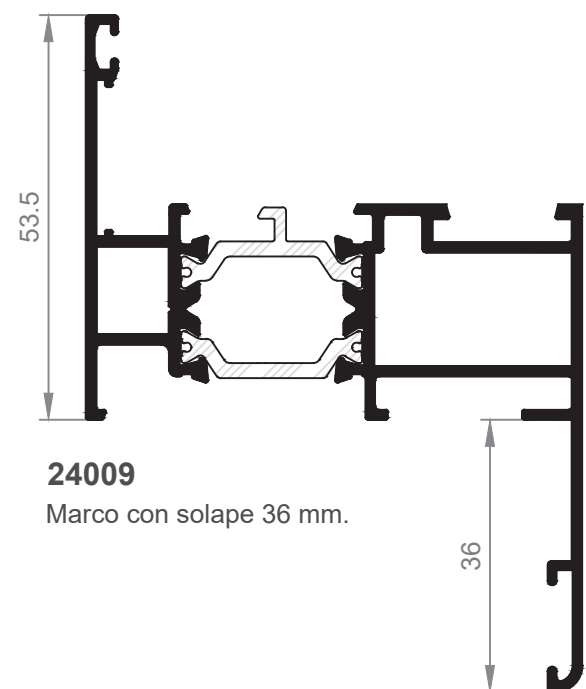

24009
Marco con solape 36 mm.

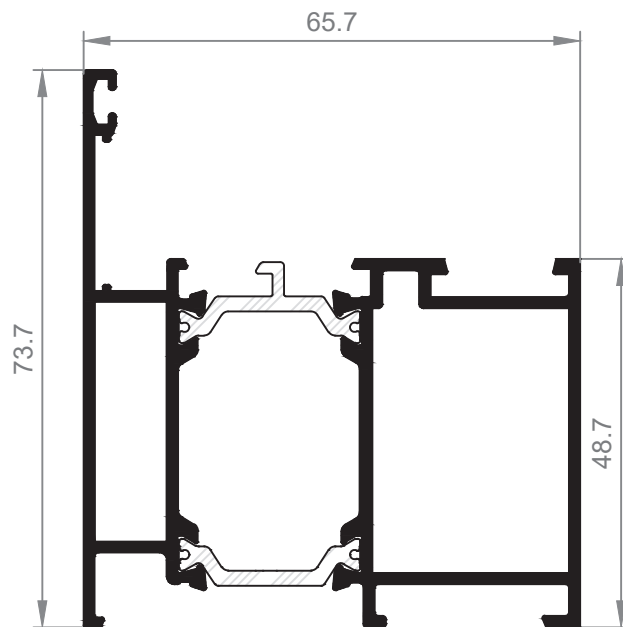
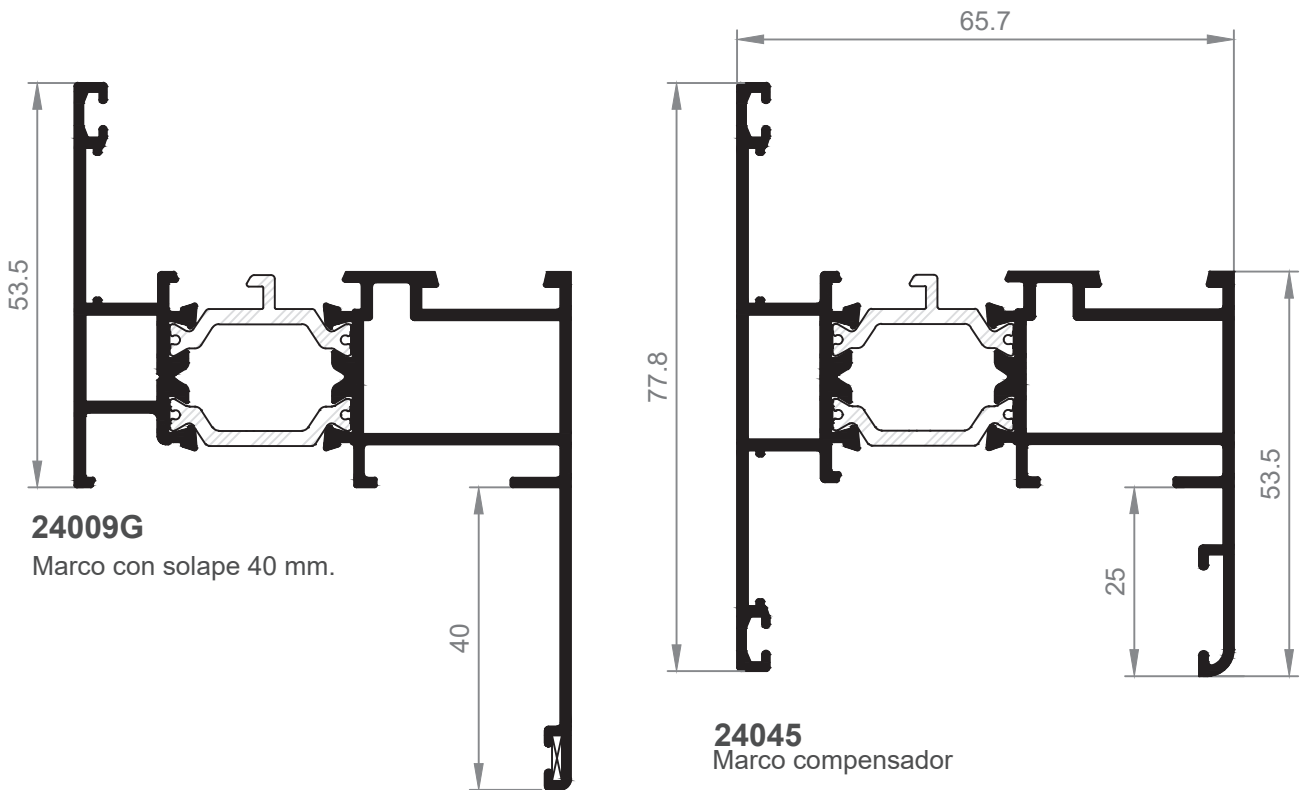

24021
Marco Puerta

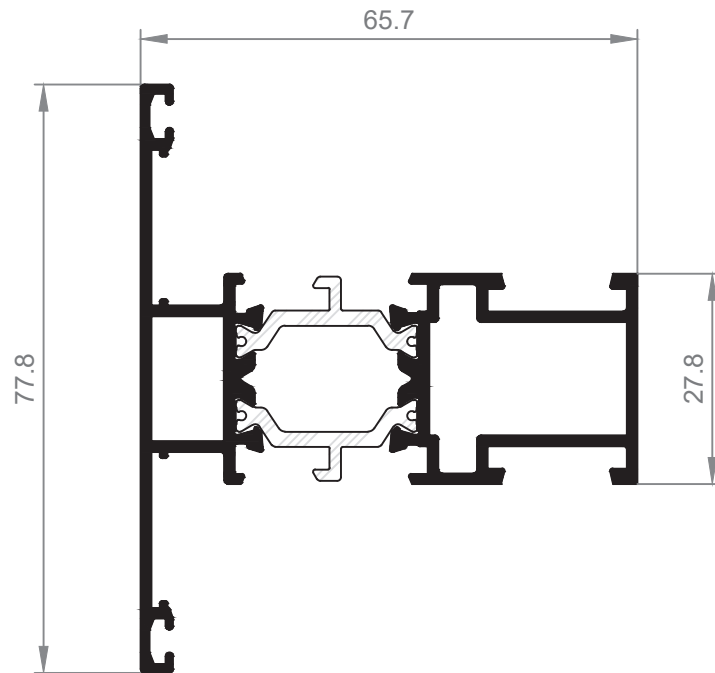

24003
Travesaño

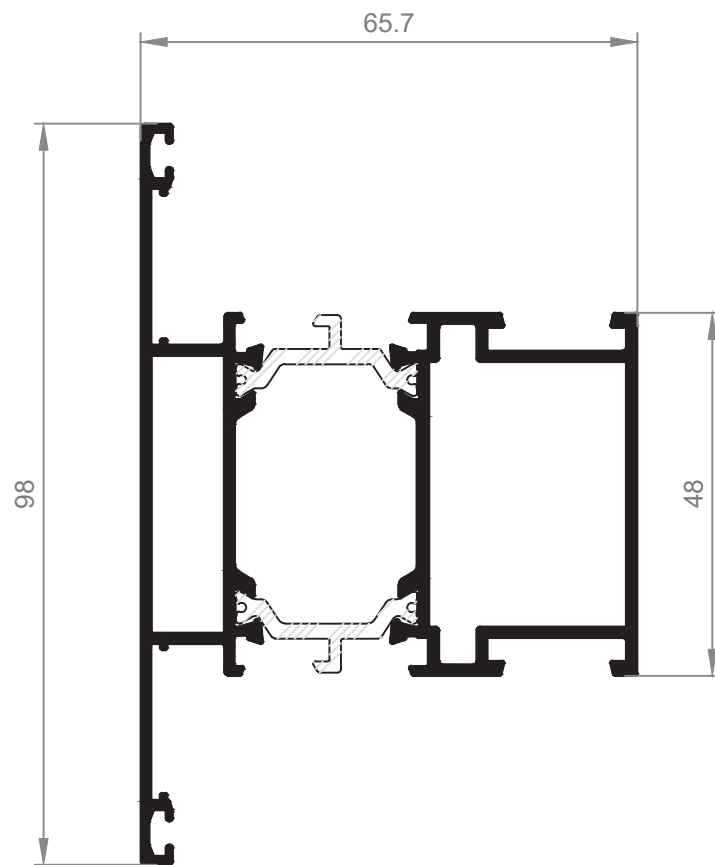

24023
Travesaño

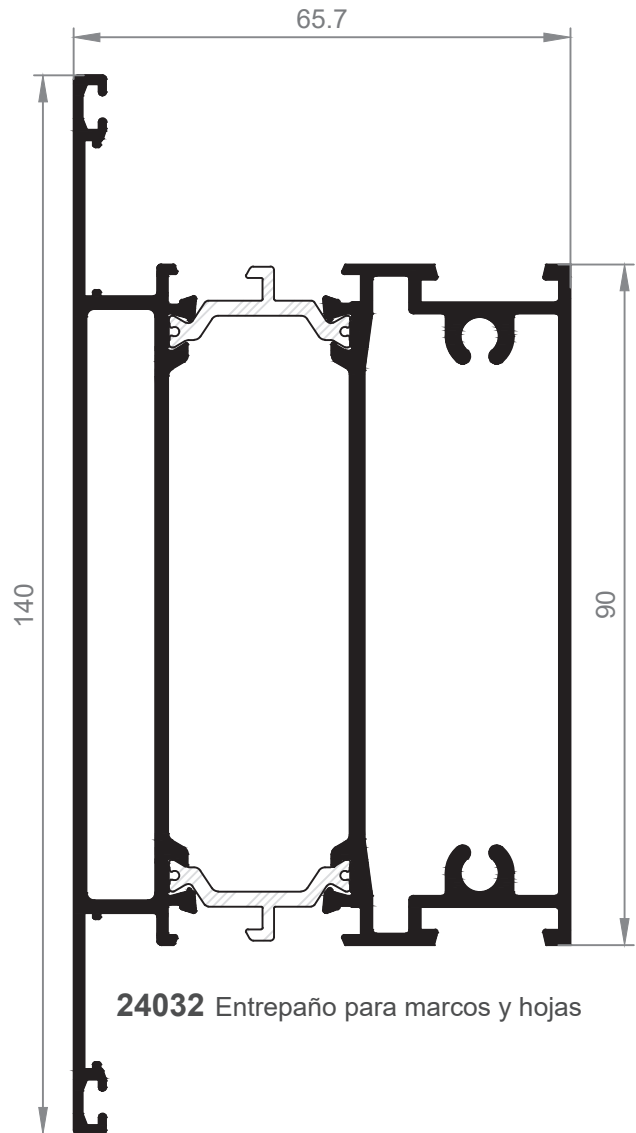
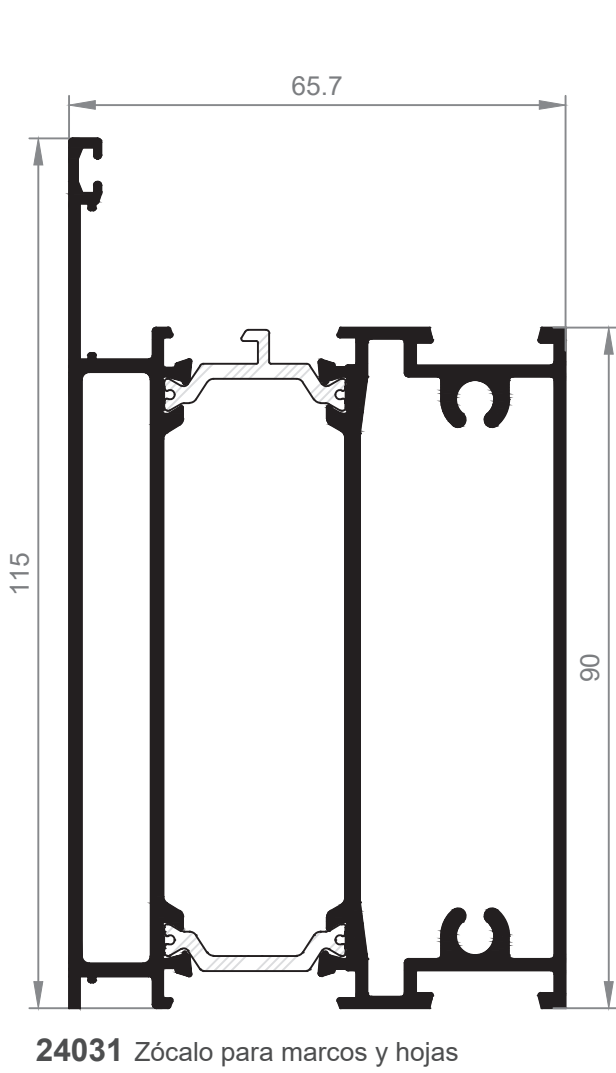

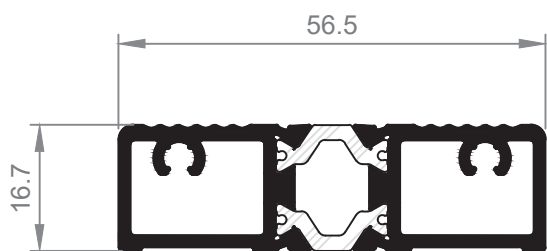

24658
Pisadera rotura Platinum 66

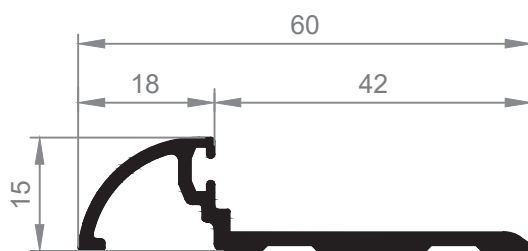

158
Perfil Suelo

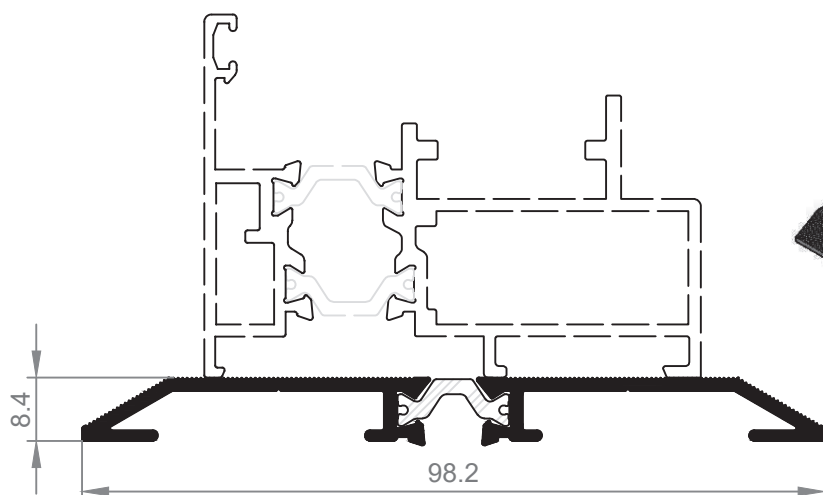

24159
Pisadera Rotura 8.4x98mm.

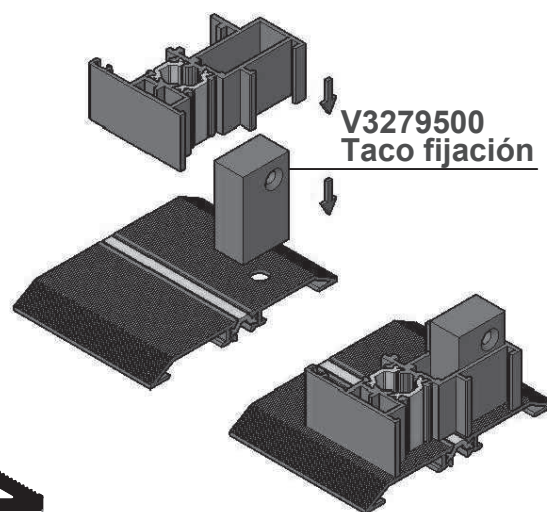

Montaje ref. 24159

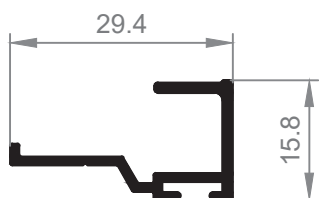

24643
Terminal Hoja puerta con Pisadera

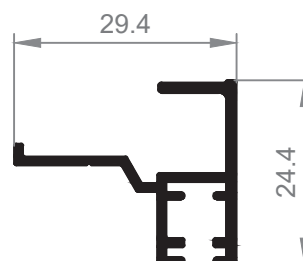

24642
Terminal Hoja puerta sin Pisadera

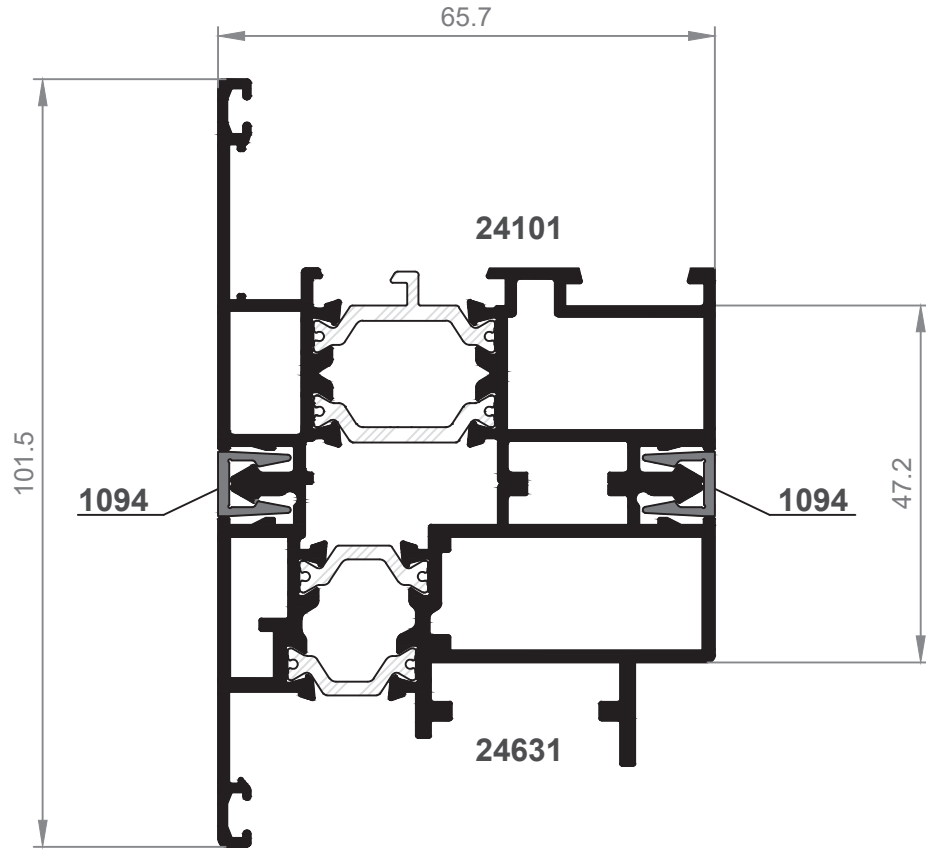

Unión marcos mediante clip ref. 1094

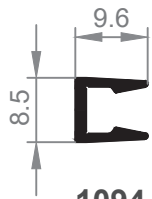

1094
Unión marcos con clip

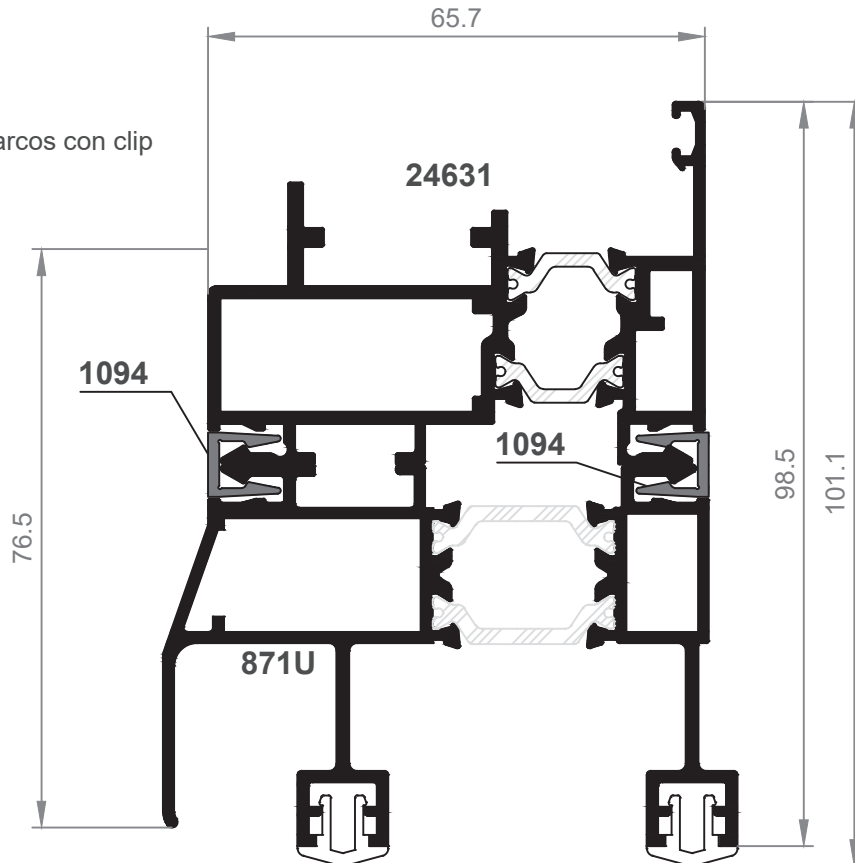

Unión marcos ref. 24631 y 871U mediante clip ref. 1094

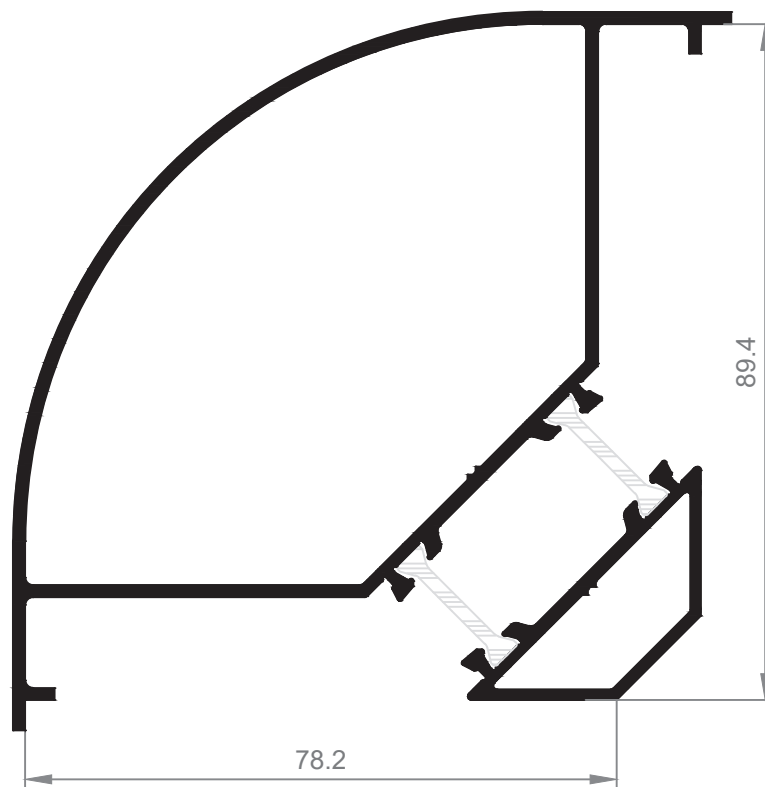

168

Esquinero fijo RPT de 77 mm.

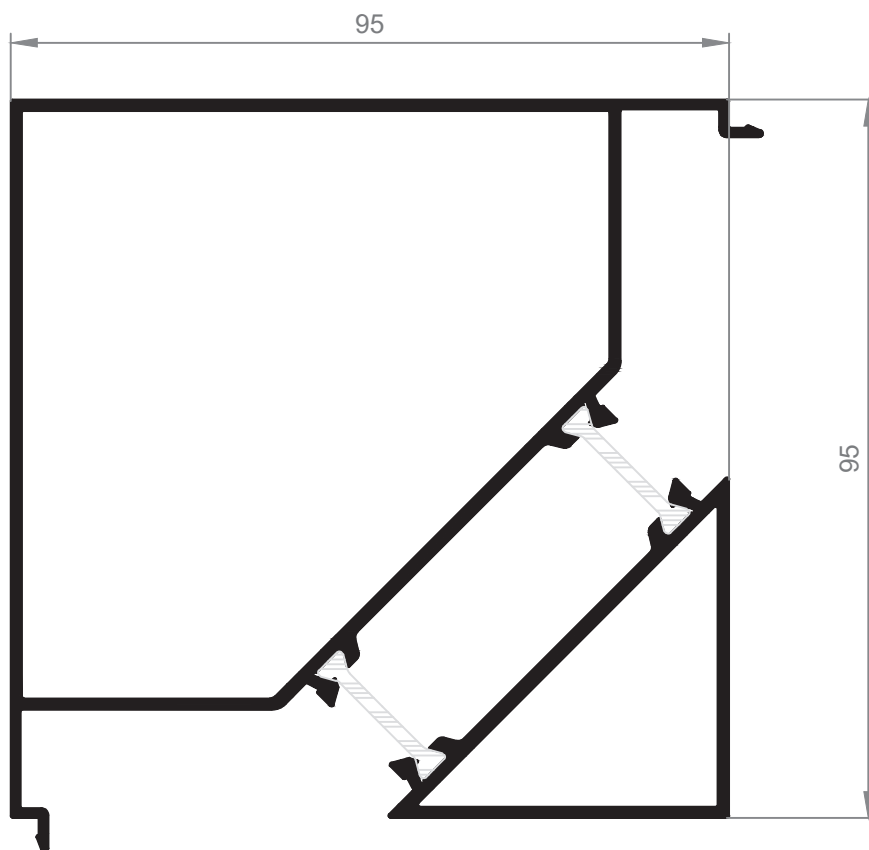

70

Esquinero fijo RPT de 95 mm.

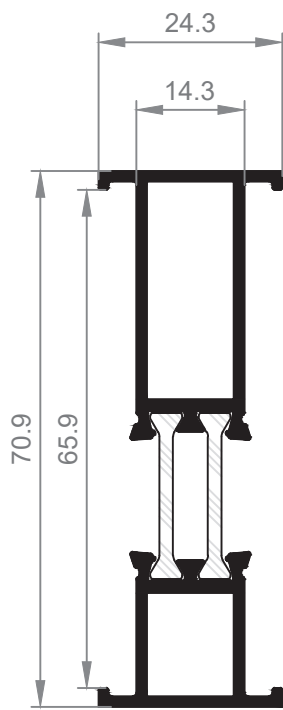

24000
Union Marcos

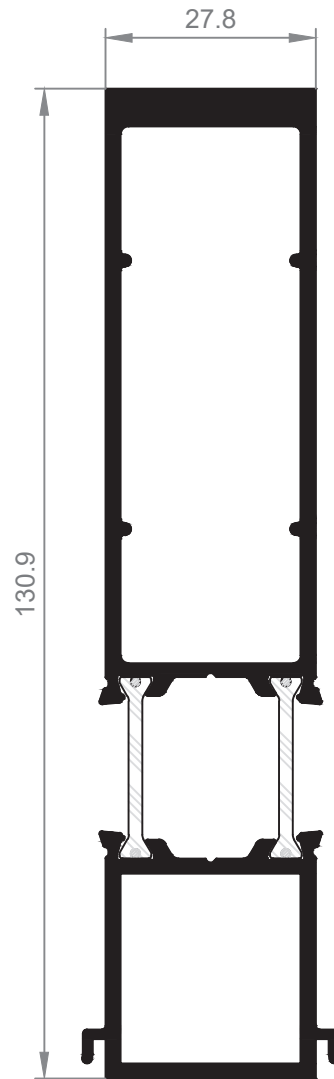

24112
Union RT Refuerzo

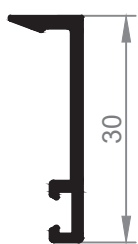

344
Tapajuntas 30 mm.
Clip Frontal

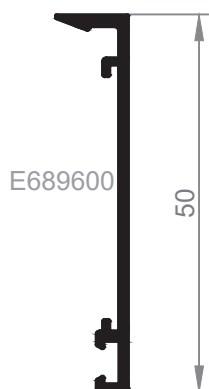

345
Tapajuntas 50 mm.
Clip Frontal

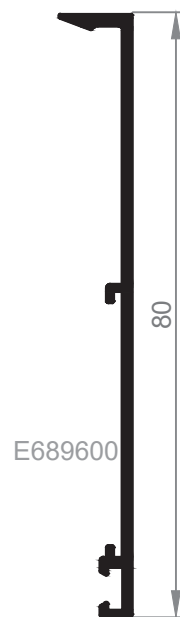

346
Tapajuntas 80 mm.
Clip Frontal

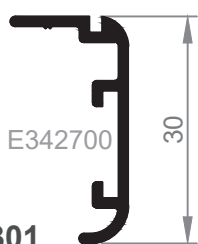
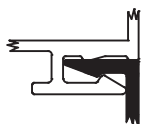

301
Tapajuntas

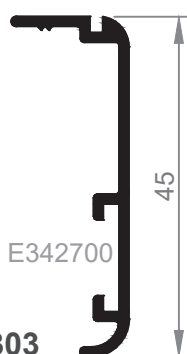

303
Tapajuntas

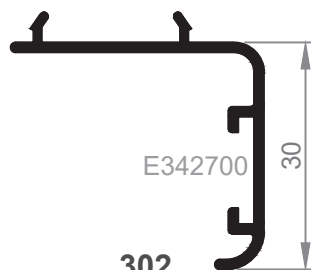

302
Tapajuntas Clipado

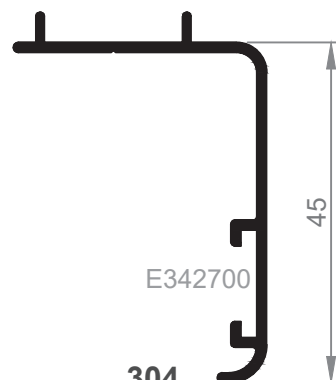

304
Tapajuntas Clipado

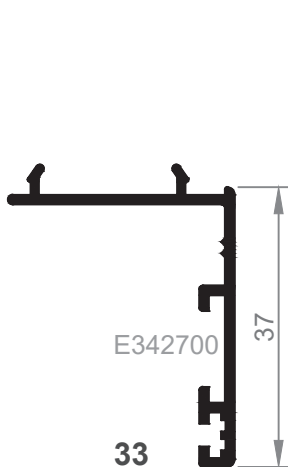

33
Tapajuntas 37 Clipado



34
Tapajuntas 37

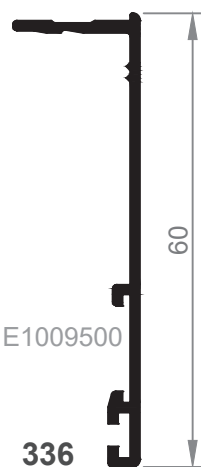

336
Tapajuntas 60



V1930000
Clip frontal aluminio

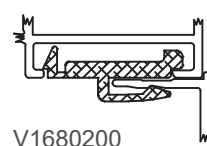

V1680200
Grapa plástico
tapajuntas frontal

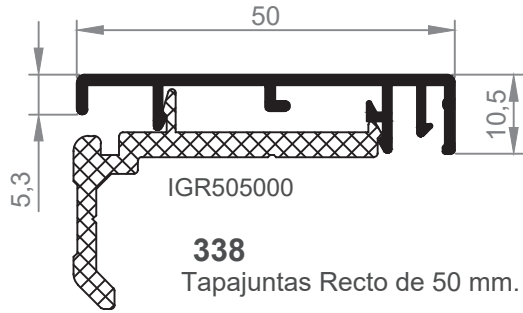

E690200 CHAPA

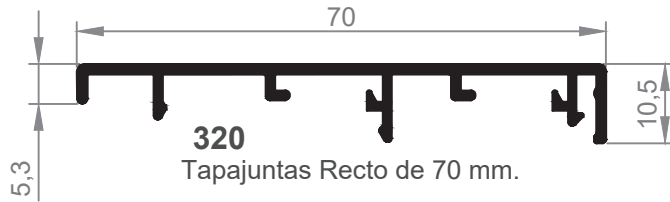

E630900 FUJI



E342700

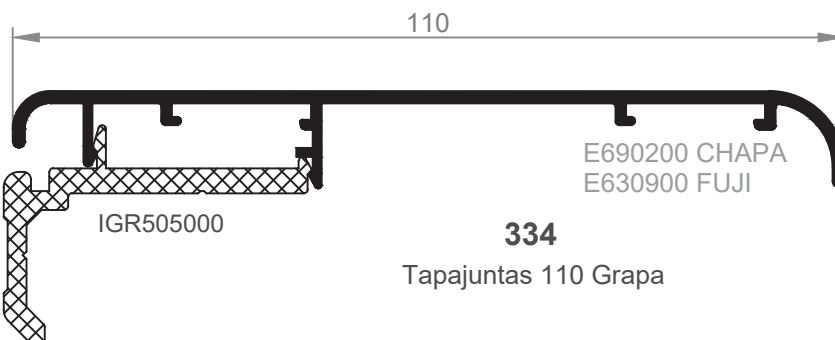
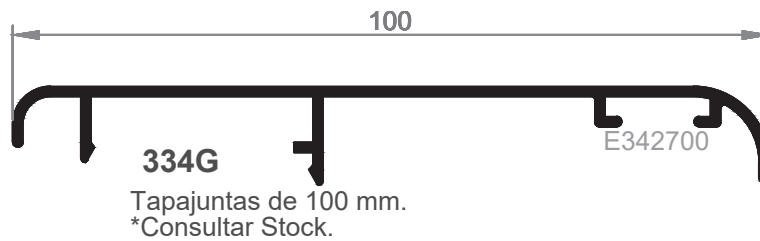

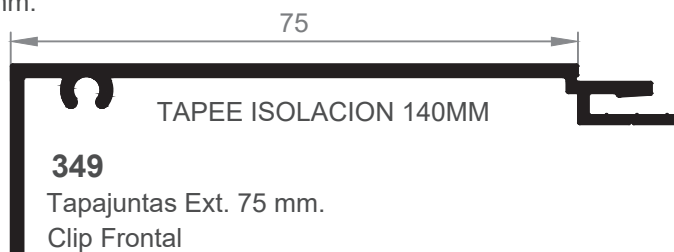
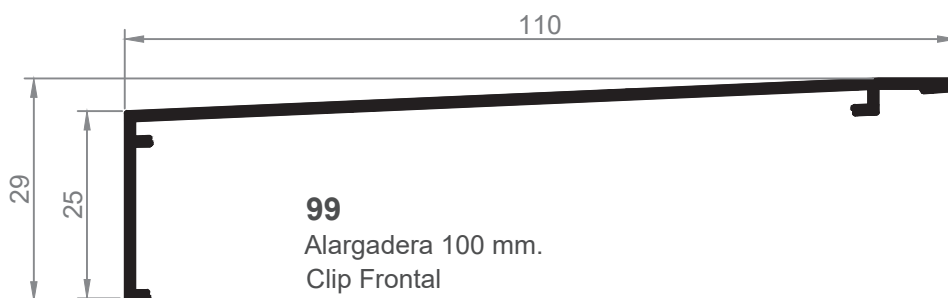
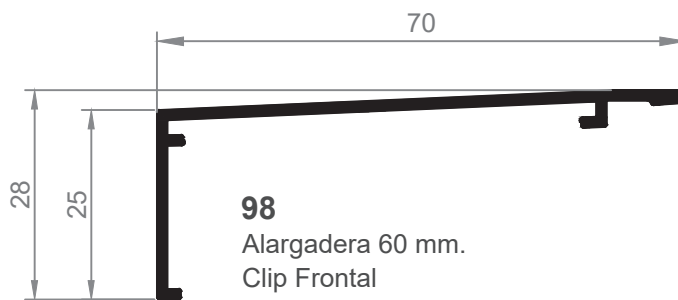

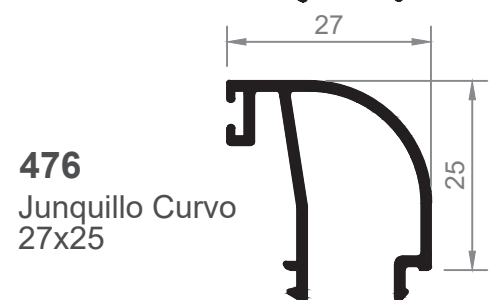
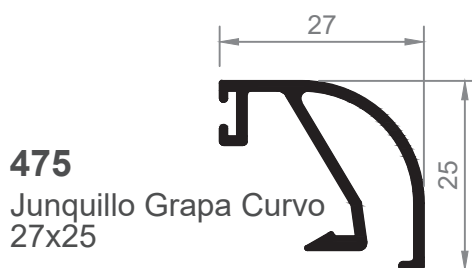
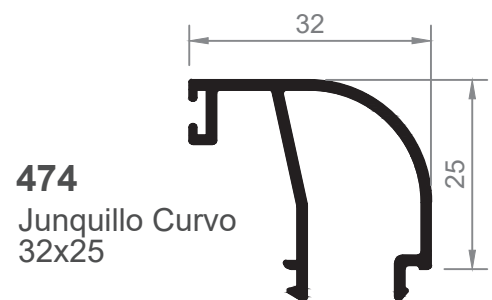
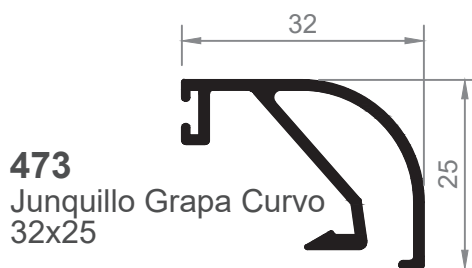
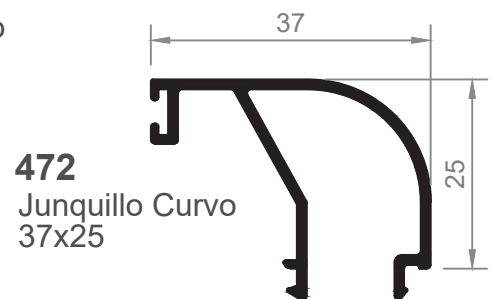
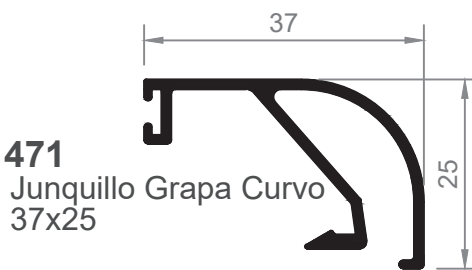
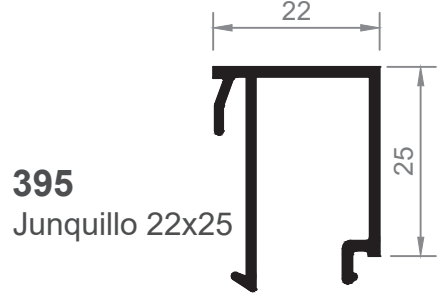
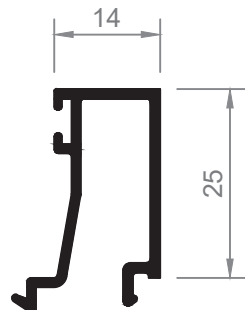
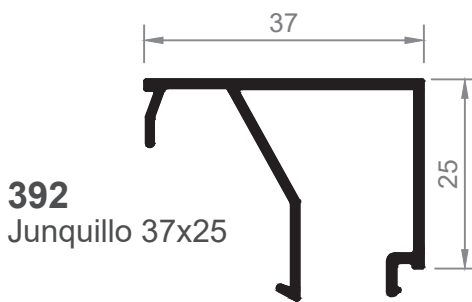
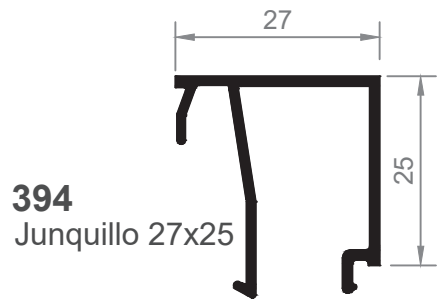
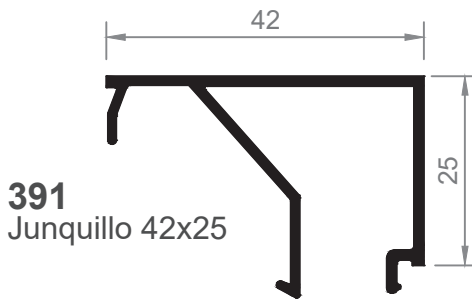
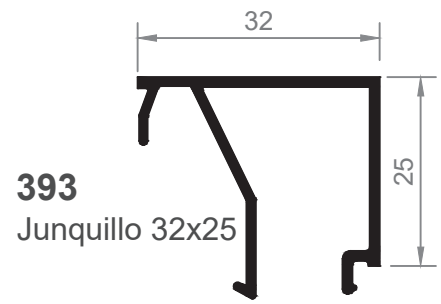
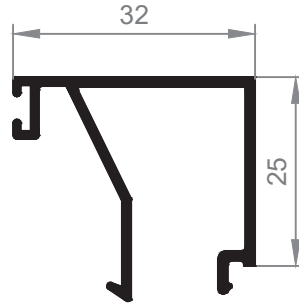
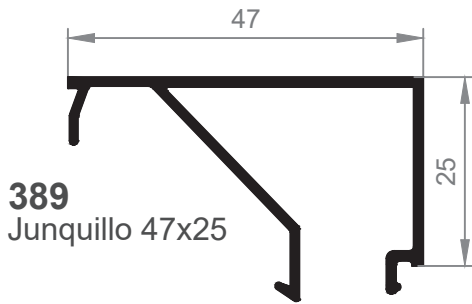

MEDIDAS HUECO JUNQUILLOS









TABLA DE ACRISTALAR AJUNQUILLAMIENTO Y GOMAS MARCOS Y HOJAS

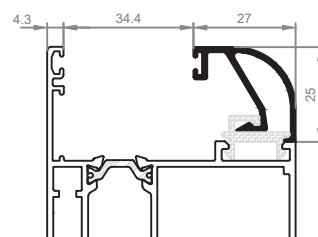
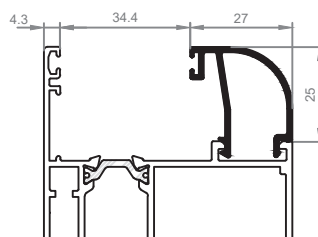
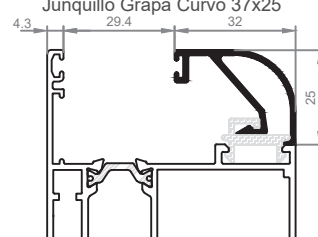
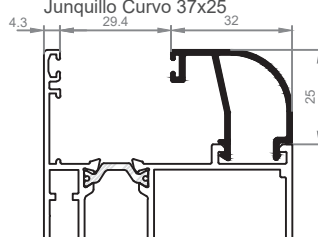
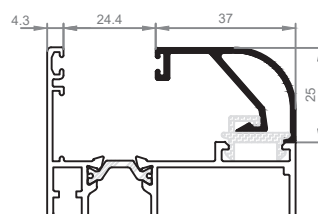
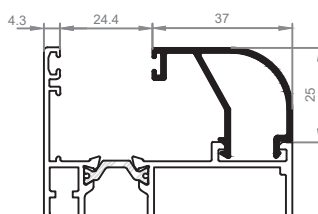
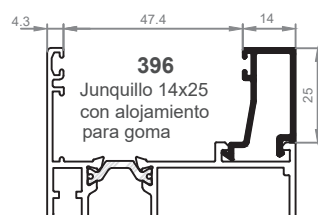
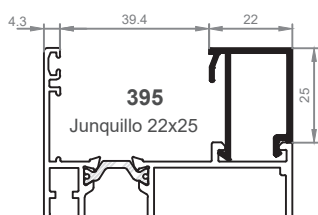
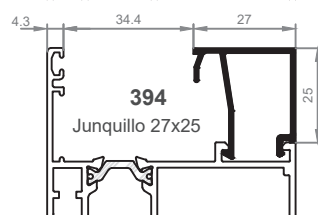
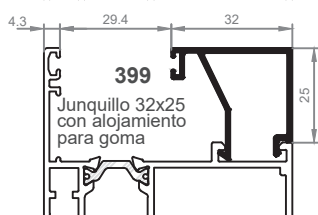
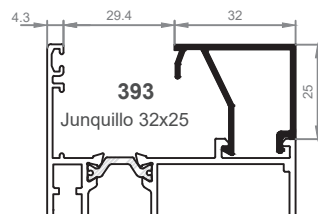
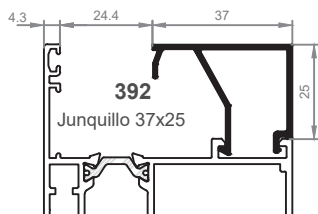
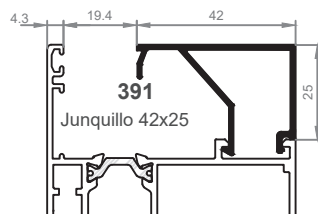
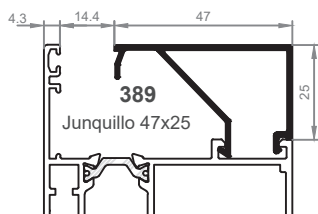
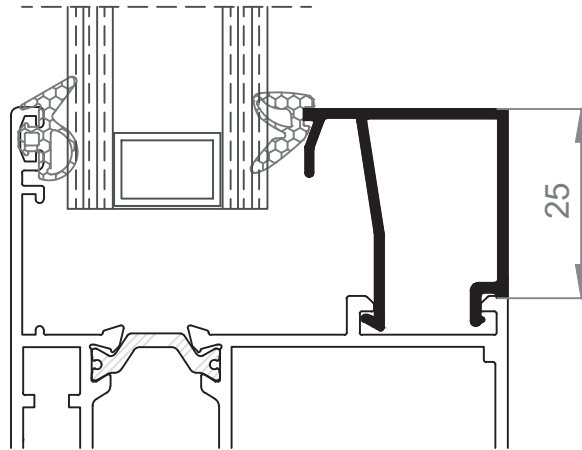
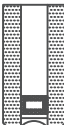



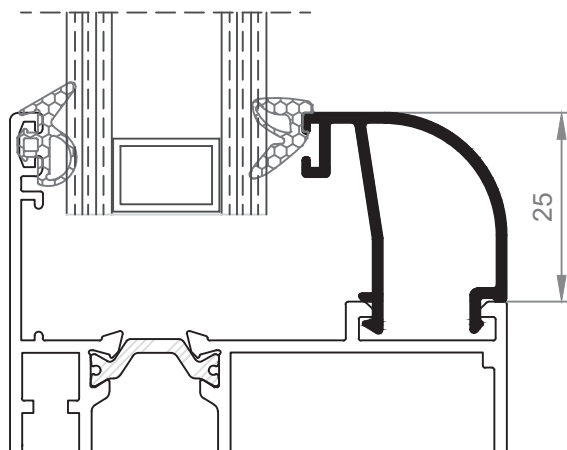

		Junta Interior				
e=2.5	espesor	e=4	e=6	e=8		
G237000						
G091700						
Junta Exterior	Vidrio	G417000	G407000	G397000	Junquillo	
	6		●		389	
	8	●			389	
	8			●	391	
	10		●		391	
	12	●			391	
	14			●	392	
	16		●		392	
	18	●			392	
	18			●	393/399	
	20		●		393/399	
	22	●			393/399	
	24			●	394	
	26		●		394	
	28	●			394	
	28			●	395	
	30		●		395	
	32	●			395	
36			●	396		
38		●		396		
40	●			396		

Esta tabla se proporciona a título informativo, en la práctica puede haber algunas diferencias en función de las tolerancias de los diversos materiales empleados (aluminio, vidrio, juntas de EPDM)

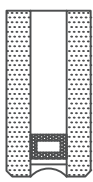
TABLA DE ACRISTALAR AJUNQUILLAMIENTO Y GOMAS MARCOS Y HOJAS



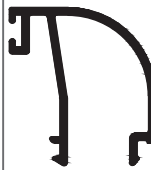



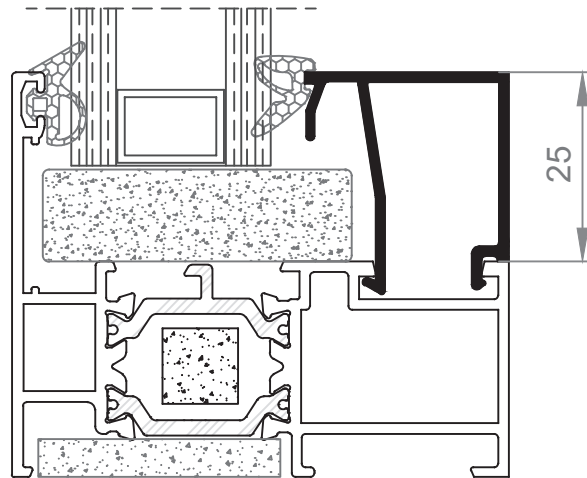

		Junta Interior			
e=2.5	espesor	e=4	e=6	e=8	
G237000					
G091700					
Junta Exterior	Vidrio	G417000	G407000	G397000	Junquillo
	14			●	472/471
	16		●		472/471
	18	●			472/471
	18			●	474/473
	20		●		474/473
	22	●			474/473
	24			●	476/475
	26		●		476/475
	28	●			476/475

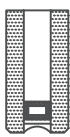
Esta tabla se proporciona a título informativo, en la práctica puede haber algunas diferencias en función de las tolerancias de los diversos materiales empleados (aluminio, vidrio, juntas de EPDM)

TABLA DE ACRISTALAR AJUNQUILLAMIENTO Y GOMAS MARCOS S/24000RT





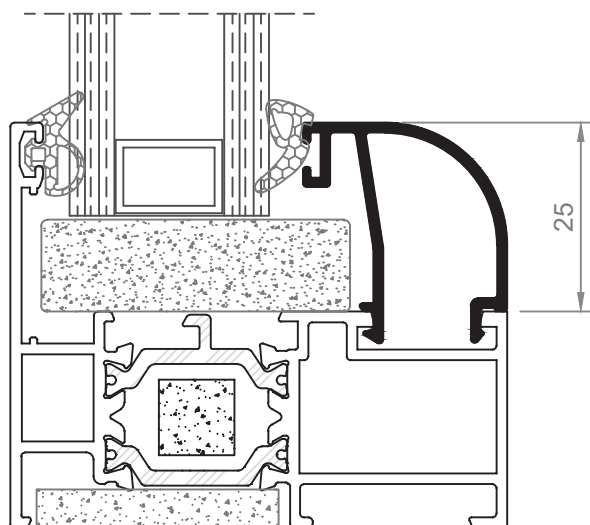

		Junta Interior			
e=2.5	espesor	e=4	e=6	e=8	
G237000					
G091700					
Junta Exterior	Vidrio	G417000	G407000	G397000	Junquillo
	6		●		389
	8	●			389
	8			●	391
	10		●		391
	12	●			391
	14			●	392
	16		●		392
	18	●			392
	18			●	393/399
	20		●		393/399
	22	●			393/399
	24			●	394
	26		●		394
	28	●			394
	28			●	395
	30		●		395
32	●			395	
36			●	396	
38		●		396	
40	●			396	

Esta tabla se proporciona a título informativo, en la práctica puede haber algunas diferencias en función de las tolerancias de los diversos materiales empleados (aluminio, vidrio, juntas de EPDM)

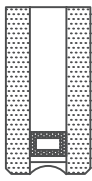
TABLA DE ACRISTALAR AJUNQUILLAMIENTO Y GOMAS MARCOS S/24000RT

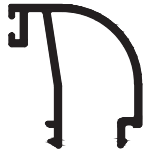

		Junta Interior			
e=2.5	espesor	e=4	e=6	e=8	
G237000					
G091700					
Junta Exterior	Vidrio	G417000	G407000	G397000	Junquillo
	14			●	472/471
	16		●		472/471
	18	●			472/471
	18			●	474/473
	20		●		474/473
	22	●			474/473
	24			●	476/475
	26		●		476/475
	28	●			476/475

Esta tabla se proporciona a título informativo, en la práctica puede haber algunas diferencias en función de las tolerancias de los diversos materiales empleados (aluminio, vidrio, juntas de EPDM)

Tapa interior guía clip

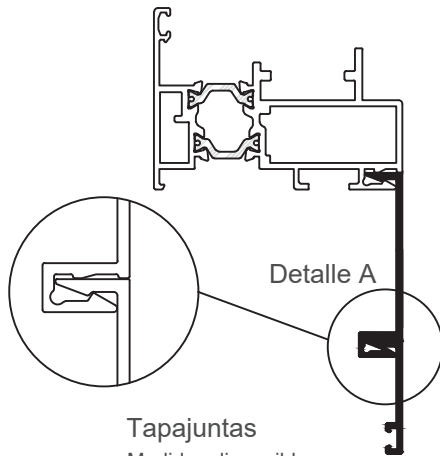

Tapajuntas
Medidas disponibles:
30 mm, 50 mm y 80 mm

Esquinero Fijo

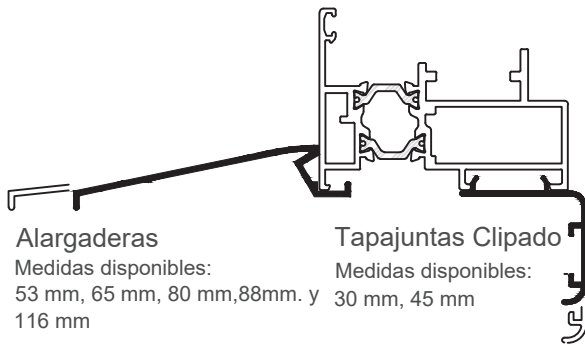
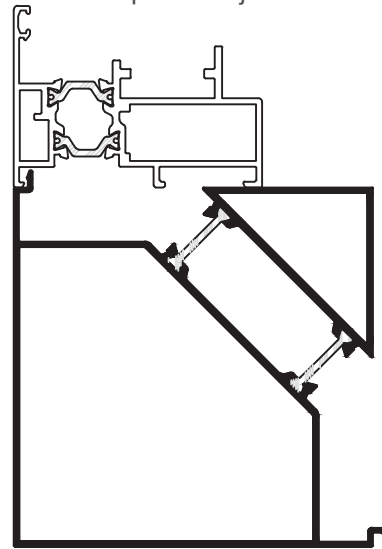

Alargaderas
Medidas disponibles:
53 mm, 65 mm, 80 mm, 88 mm. y
116 mm

Tapajuntas Clipado
Medidas disponibles:
30 mm, 45 mm

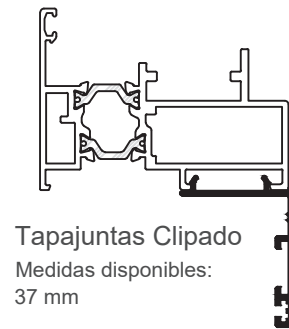

Tapajuntas Clipado
Medidas disponibles:
37 mm

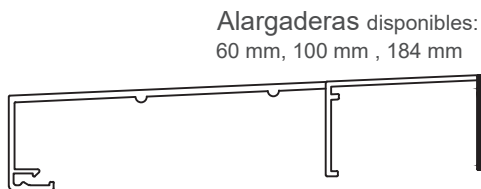

Alargaderas disponibles:
60 mm, 100 mm, 184 mm

Tapee Isolacion

Medidas disponibles:
55 mm, 75 mm, 95 mm

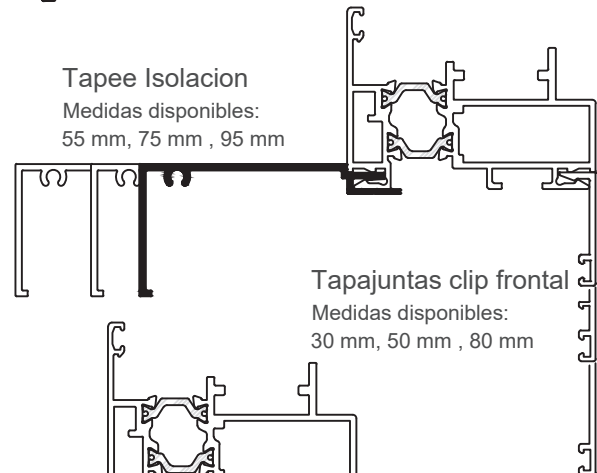

Tapajuntas clip frontal

Medidas disponibles:
30 mm, 50 mm, 80 mm

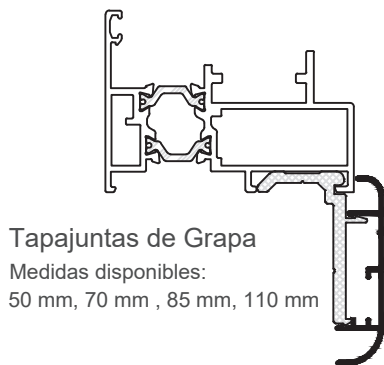

Tapajuntas de Grapa
Medidas disponibles:
50 mm, 70 mm, 85 mm, 110 mm

Tapajuntas recto de Grapa

Medidas disponibles: 50 y 70 mm.

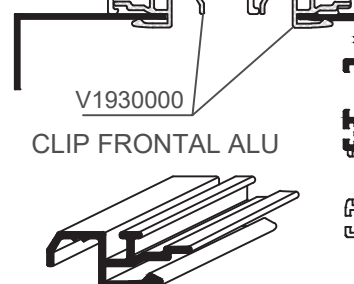

Tapajuntas

Medidas disponibles:
37 mm, 60 mm.

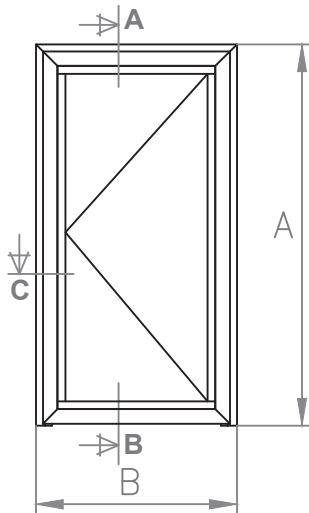

Puerta 1 Hoja
Apertura Interior

Sección A-B

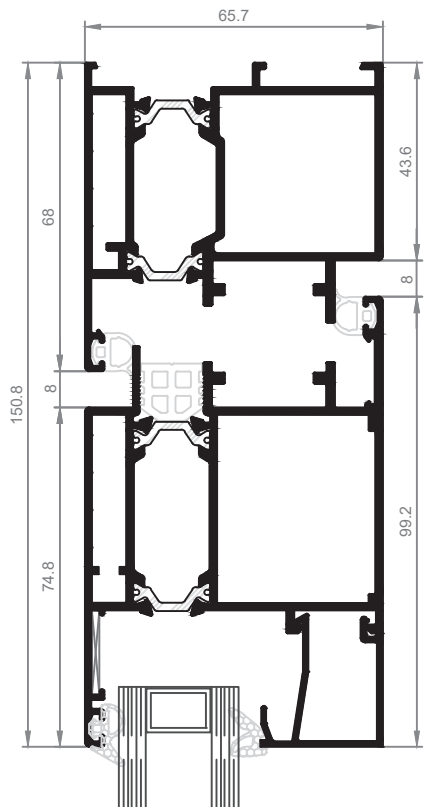

Detalle C

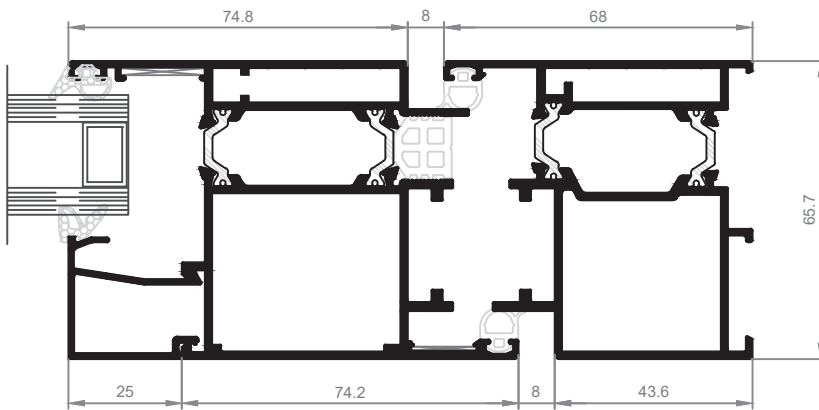

VARIANTE SIN PISADERA

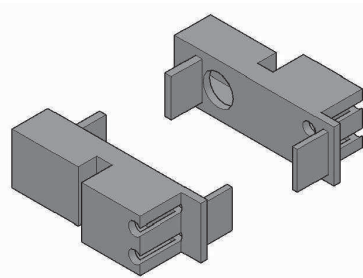
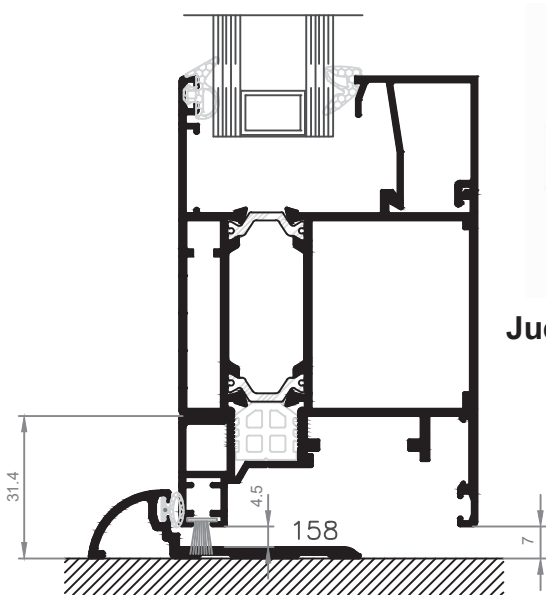

**Juego tapones pisadera
(opcional)
TP6910802**

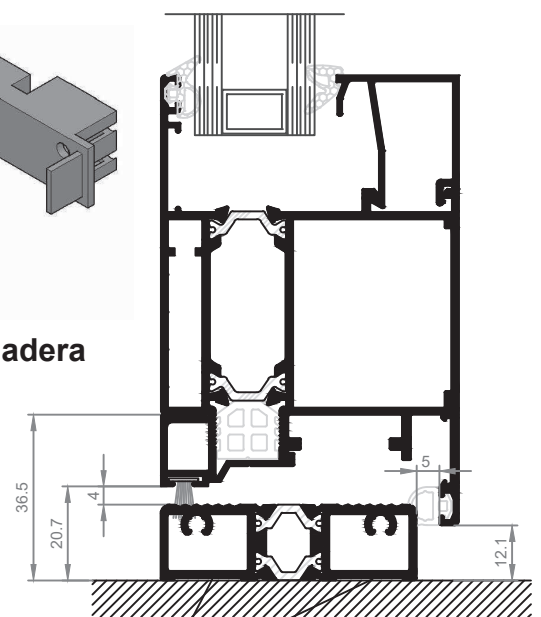

Cama de silicona

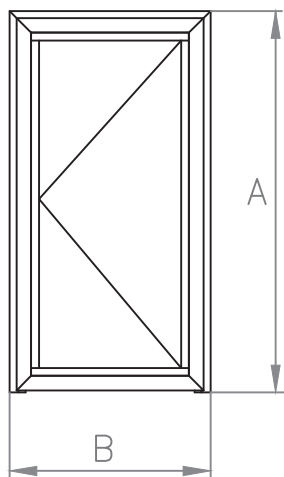

Puerta 1 Hoja
Apertura Interior

Acristalamiento		
Uds.	Alto	Ancho
1	A-238	B-277

Nota:

- (1) Ver tabla acristalamiento.
- (2) Consultar diferentes modelos en catálogo.

Pos	Uds.	Nt.	Referencia	Croquis	Denominación	Corte	Longitud en m/m.
Marco	1		24621		Marco Puerta	45° 90°	A
	1		24621		Marco Puerta	90° 45°	A
	1		24621		Marco Puerta	45° 45°	B
Hoja	2		24622		Hoja Puerta	45° 45°	A-64
	2		24622		Hoja Puerta	45° 45°	B-103
	1		24643		Terminal Hoja	90° 90°	B-152
	1		24658		Perfil Inferior	90° 90°	B-87
	2	(1)	Ver nota		Junquillo	90° 90°	A-262
	2	(1)	Ver nota		Junquillo	90° 90°	B-252

Pos	Uds.	Nt.	Referencia	Denominación
Accesorios	2		E1260200	Escuadra Bloqueo Marco
	4		E1250200+E1240000	Escuadra Bloqueo Hoja
	6		E1270900	Escuadra Balín Hoja y Marco puerta
	4		E1009500	Escuadra Alineamiento interior hoja
	4		E630900	Escuadra Alineamiento exterior hoja
	3	(2)	B5741XX	Bisagra Puerta
	1	(2)	V13570XX	Juego Manilla Puerta
	1	(2)		Cerradura
	1		TP6110800	Juego tapones bajo puerta para 24642
Juntas	4A+3B		G787000	Junta Batiente
	2A+2B		G797000	Junta Tapa Canal
	1B		VC51	Cepillo inferior 7x6
	2A+2B	(1)		Goma Exterior acristalar
	2A+2B	(1)		Goma Interior acristalar

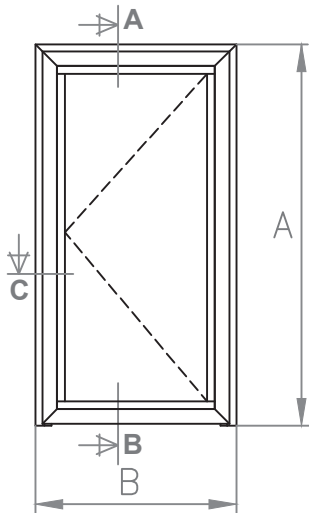

Puerta 1 Hoja
Apertura Exterior

Sección A-B

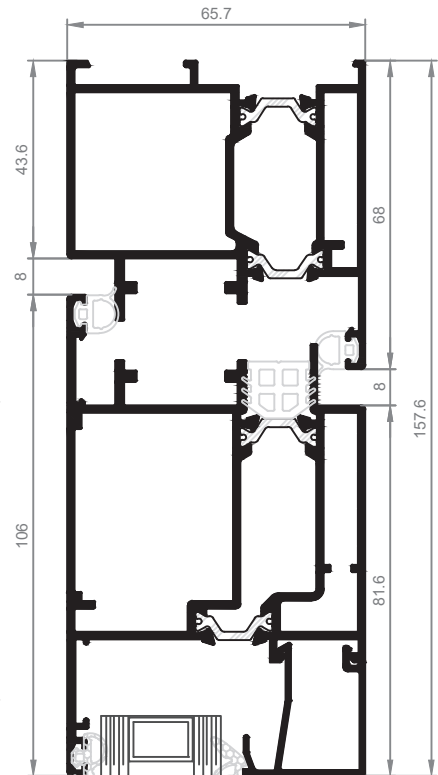

Detalle C

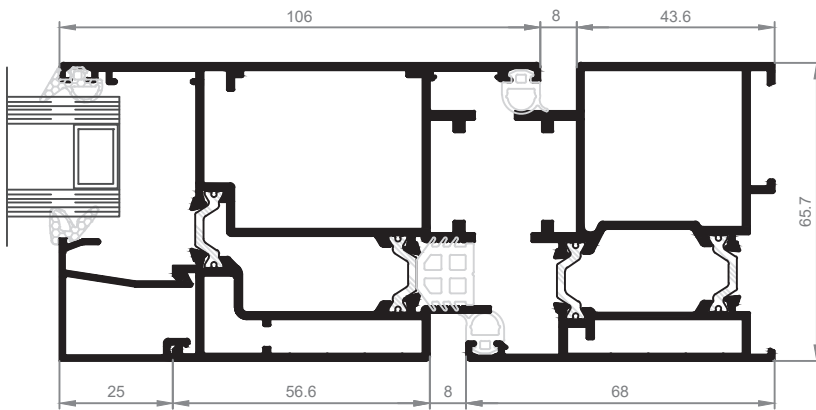

VARIANTE SIN PISADERA

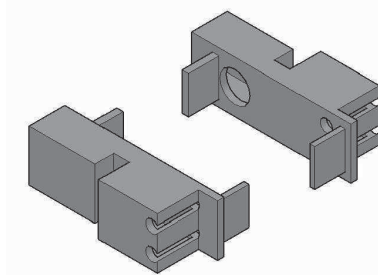
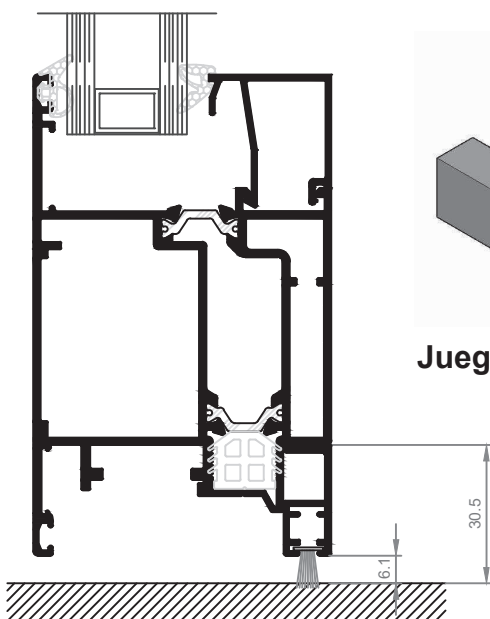

Juego tapones pisadera
(opcional)
TP6910802

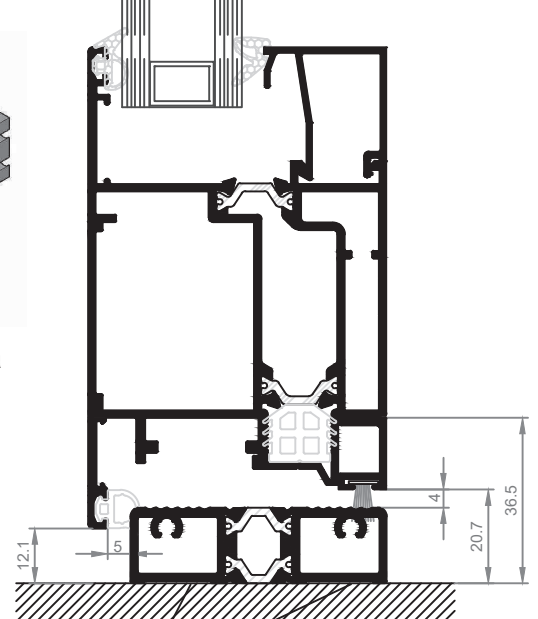

Cama de silicona

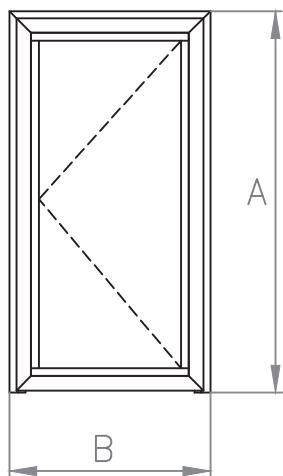

Puerta 1 Hoja
Apertura Exterior

Acristalamiento		
Uds.	Alto	Ancho
1	A-252	B-292

Nota:

- (1) Ver tabla acristalamiento.
- (2) Consultar diferentes modelos en catálogo.

Pos	Uds.	Nt.	Referencia	Croquis	Denominación	Corte	Longitud en m/m.
Marco	1		24621		Marco Puerta	45° 90°	A
	1		24621		Marco Puerta	90° 45°	A
	1		24621		Marco Puerta	45° 45°	B
Hoja	2		24628		Hoja Puerta	45° 45°	A-64
	2		24628		Hoja Puerta	45° 45°	B-103
	1		24643		Terminal Hoja	90° 90°	B-152
	1		24658		Perfil Inferior	90° 90°	B-87
	2	(1)	Ver nota		Junquillo	90° 90°	A-276
	2	(1)	Ver nota		Junquillo	90° 90°	B-265

Pos	Uds.	Nt.	Referencia	Denominación
Accesorios	2		E1260200	Escuadra Bloqueo Marco
	4		E1250200+E1240000	Escuadra Bloqueo Hoja
	6		E1270900	Escuadra Balín Hoja y Marco puerta
	4		E1009500	Escuadra Alineamiento interior hoja
	4		E630900	Escuadra Alineamiento exterior hoja
	3	(2)	B5741XX	Bisagra Puerta
	1	(2)	V13570XX	Juego Manilla Puerta
	1	(2)		Cerradura
	1		TP6110800	Juego tapones bajo puerta para 24642
Juntas	4A+3B		G787000	Junta Batiente
	2A+2B		G797000	Junta Tapa Canal
	1B		VC51	Cepillo inferior 7x6
	2A+2B	(1)		Goma Exterior acristalar
	2A+2B	(1)		Goma Interior acristalar

Detalle C

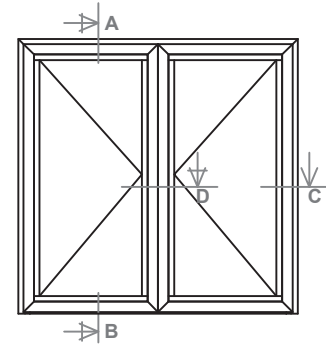
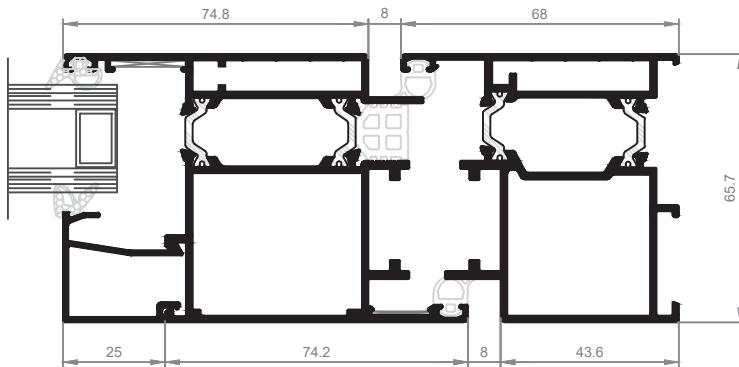

Puerta 2 Hojas
Apertura Interior

Sección A-B

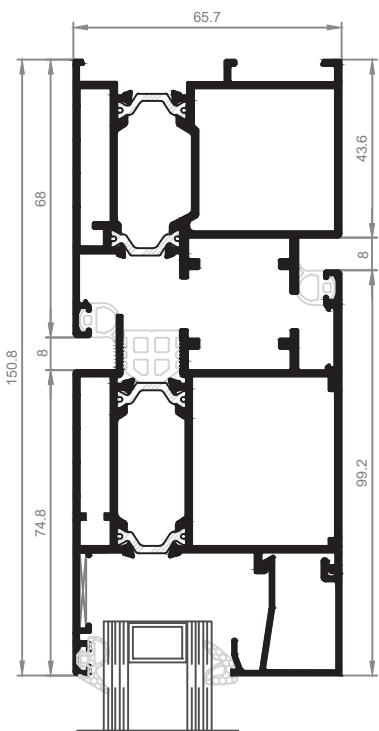

Detalle D

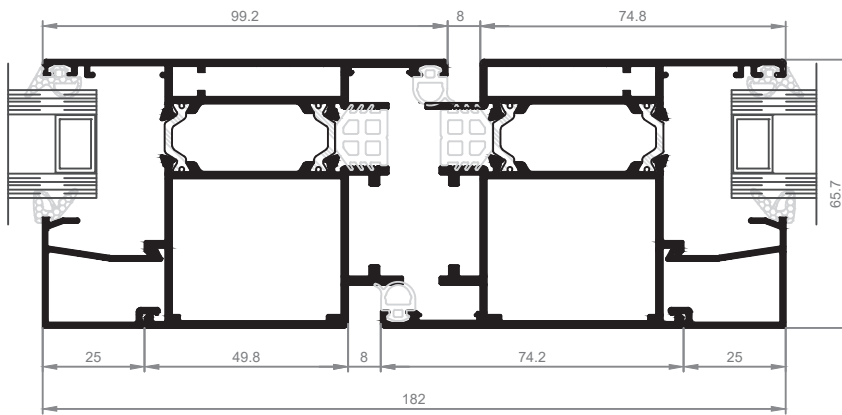

VARIANTE SIN PISADERA

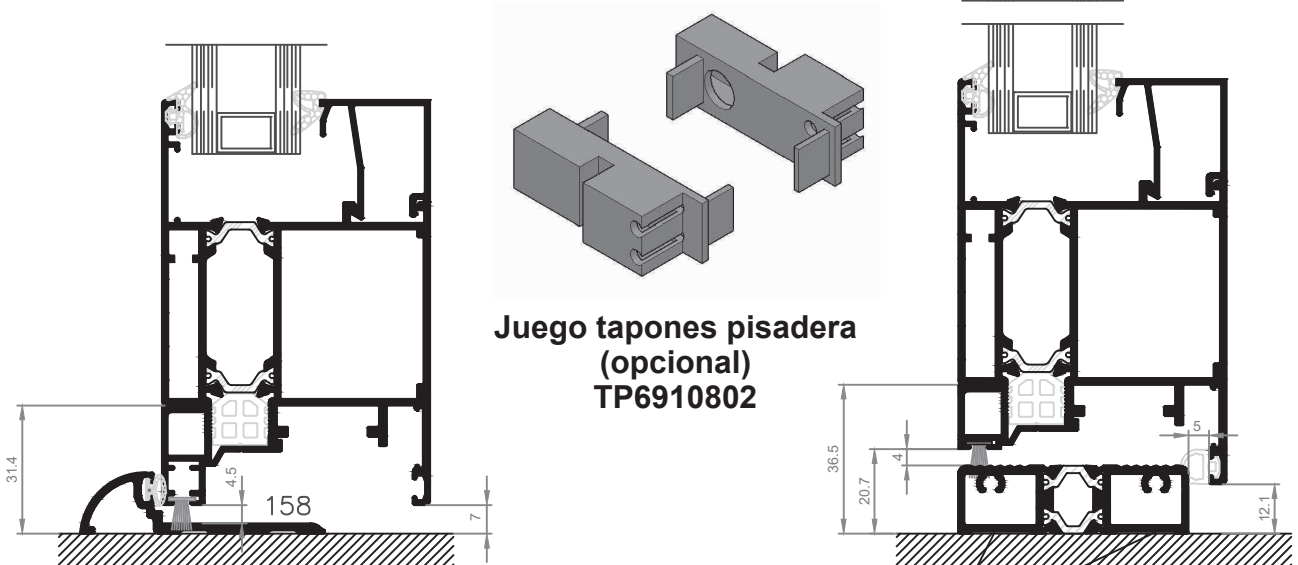

Cama de silicona

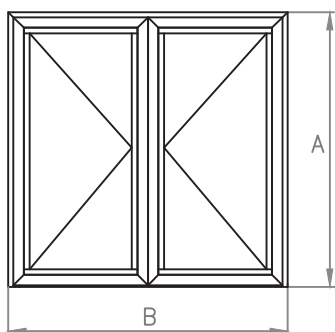

Puerta 2 Hojas
Apertura Interior

Acristalamiento		
Uds.	Alto	Ancho
2	A-238	(B-436)/2

Nota:

- (1) Ver tabla acristalamiento.
- (2) Consultar diferentes modelos en catálogo.

Pos	Uds.	Nt.	Referencia	Croquis	Denominación	Corte	Longitud en m/m.
Marco	1		24621		Marco Puerta	45° 90°	A
	1		24621		Marco Puerta	90° 45°	A
	1		24621		Marco Puerta	45° 45°	B
Hoja	3		24622		Hoja Puerta	45° 45°	A-64
	1		24623		Inversor Ap. Interior	45° 45°	A-64
	4		24622		Hoja Puerta	45° 45°	(B-88)/2
	2		24643		Terminal Hoja	90° 90°	(B-184)/2
	1		24658		Perfil Inferior	90° 90°	B-87
	4	(1)	Ver nota		Junquillo	90° 90°	A-262
	4	(1)	Ver nota		Junquillo	90° 90°	(B-384)/2

Pos	Uds.	Nt.	Referencia	Denominación
Accesorios	2		E1260200	Escuadra Bloqueo Marco
	8		E1250200+E1240000	Escuadra Bloqueo Hoja
	10		E1270900	Escuadra Balín Hoja y Marco puerta
	8		E1009500	Escuadra Alineamiento interior hoja
	8		E630900	Escuadra Alineamiento exterior hoja
	6	(2)	B5741XX	Bisagra Puerta
	1	(2)	V13570XX	Juego Manilla Puerta
	1	(2)		Cerradura
	2		V2744100	Pasador puerta 250mm
	1		V2754100	Cerradero superior marco pasador
	1		V227400	Cerradero inferior suelo pasador
	1		TP6310800	Juego tapones bajo puerta para 24642
Juntas	6A+3B		G787000	Junta Batiente
	4A+2B		G797000	Junta Tapa Canal
	1B		VC51	Cepillo inferior 7x6
	4A+2B	(1)		Goma Exterior acristalar
	4A+2B	(1)		Goma Interior acristalar

Detalle C

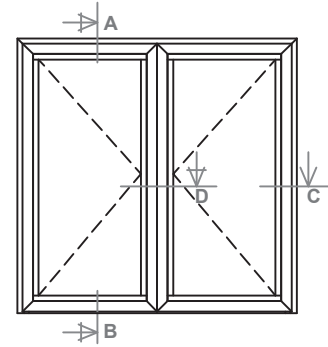
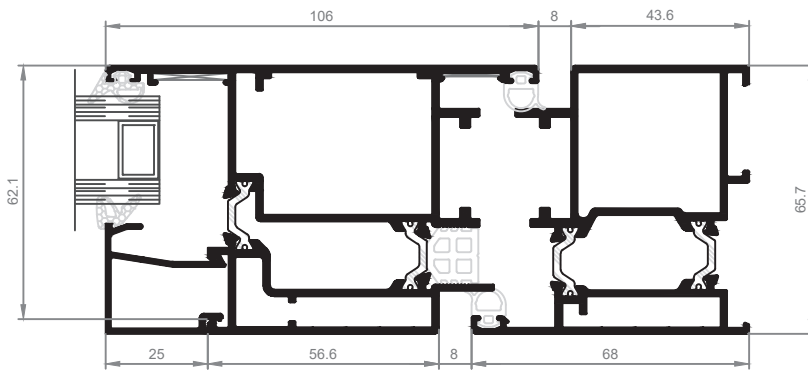

Puerta 2 Hojas
Apertura Exterior

Sección A-B

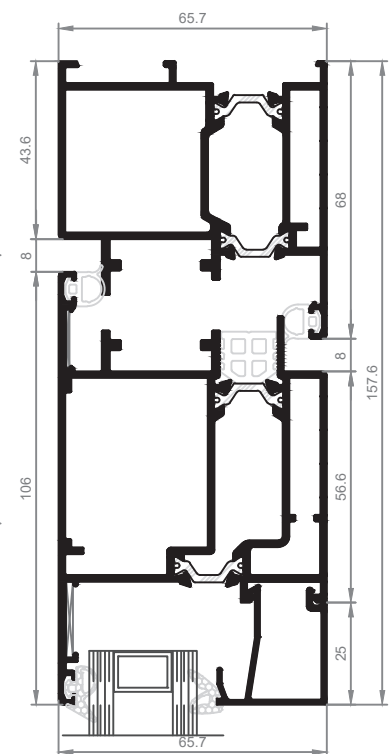

Detalle D

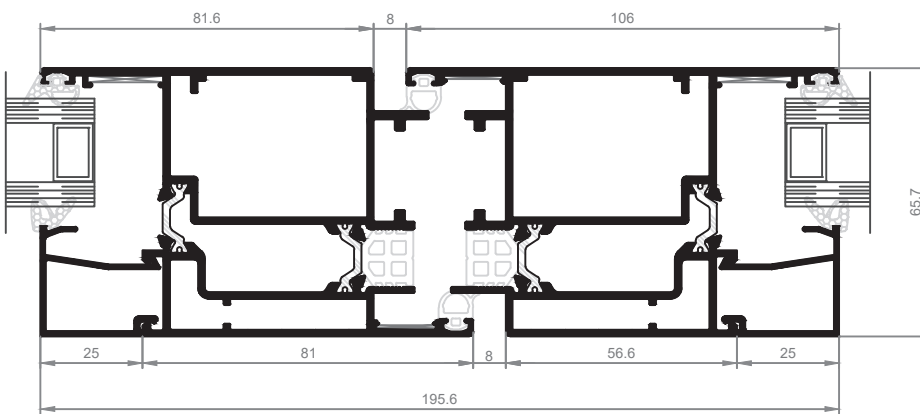

VARIANTE SIN PISADERA

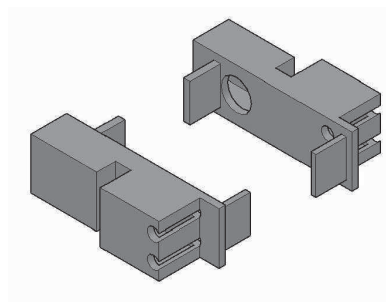
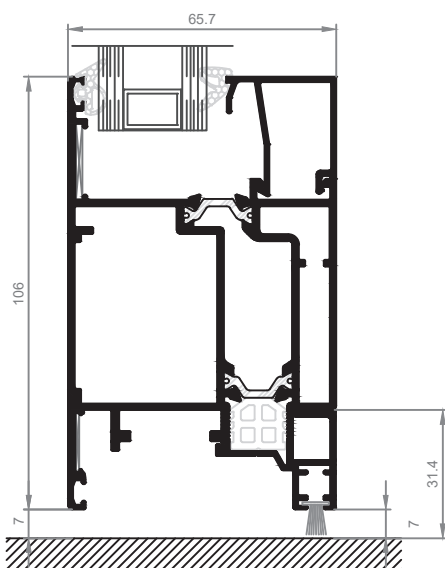

Juego tapones pisadera
(opcional)
TP6910802

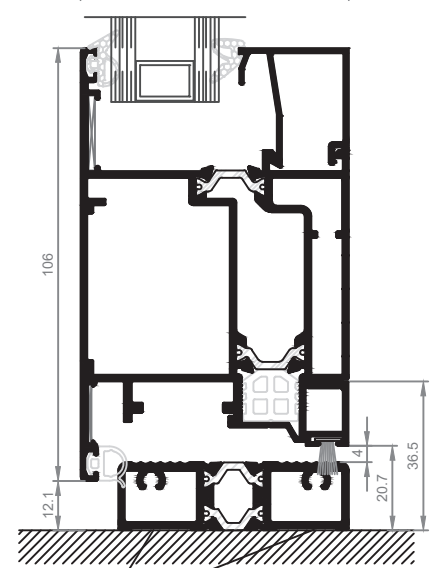

Cama de silicona

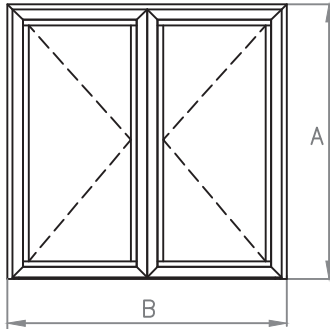









Puerta 2 Hojas
Apertura Exterior

Acristalamiento		
Uds.	Alto	Ancho
2	A-252	(B-463)/2

Nota:

- (1) Ver tabla acristalamiento.
- (2) Consultar diferentes modelos en catálogo.

Pos	Uds.	Nt.	Referencia	Croquis	Denominación	Corte	Longitud en m/m.	
Marco	1		24621		Marco Puerta	45° 90°	A	
	1		24621		Marco Puerta	90° 45°	A	
	1		24621		Marco Puerta	45° 45°	B	
Hoja	3		24628		Hoja Puerta	45° 45°	A-64	
	1		24629		Inversor Ap. Exterior	45° 45°	A-64	
	4		24628		Hoja Puerta	45° 45°	(B-88)/2	
	2		24643		Terminal Hoja	90° 90°	(B-184)/2	
	1		24658		Perfil Inferior	90° 90°	B-87	
	4	(1)	Ver nota			Junquillo	90° 90°	A-276
	4	(1)	Ver nota			Junquillo	90° 90°	(B-411)/2

Pos	Uds.	Nt.	Referencia	Denominación
Accesorios	2		E1260200	Escuadra Bloqueo Marco
	8		E1250200+E1240000	Escuadra Bloqueo Hoja
	10		E1270900	Escuadra Balín Hoja y Marco
	8		E1009500	Escuadra Alineamiento interior hoja
	8		E630900	Escuadra Alineamiento exterior hoja
	6	(2)	B5741XX	Bisagra Puerta
	1	(2)	V13570XX	Juego Manilla Puerta
	1	(2)		Cerradura
	2		V2744100	Pasador puerta 250mm
	1		V2754100	Cerradero superior marco pasador
	1		V227400	Cerradero inferior suelo pasador
	1		TP6310800	Juego tapones bajo puerta para 24642
	Juntas	6A+3B		G787000
4A+2B			G797000	Junta Tapa Canal
1B			VC51	Cepillo inferior 7x6
4A+2B		(1)		Goma Exterior acristalar
4A+2B		(1)		Goma Interior acristalar

**PUERTA 2H. PRACTICABLES APERTURA INTERIOR
CON MONTANTE FIJO**

Detalle C

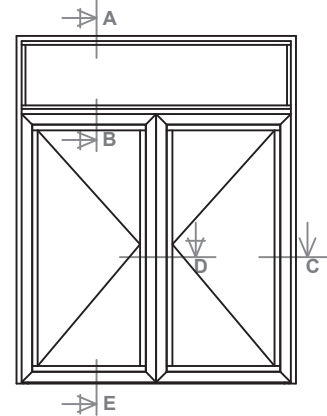
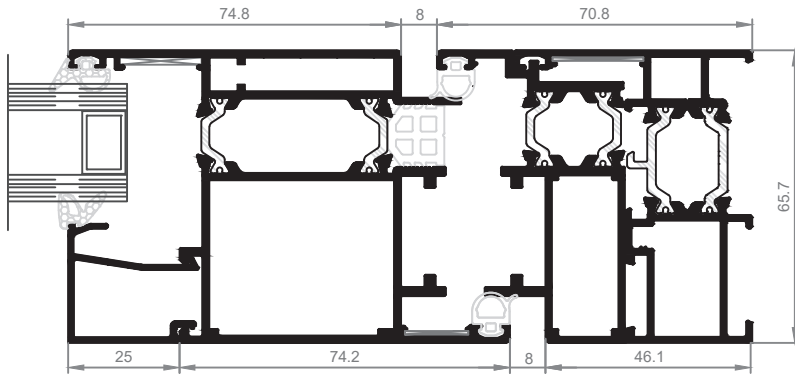

Sección A-B

Detalle D

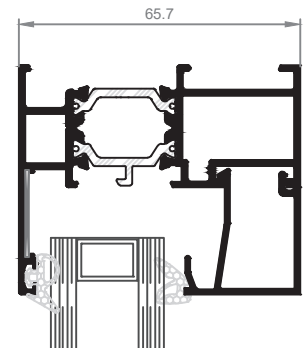
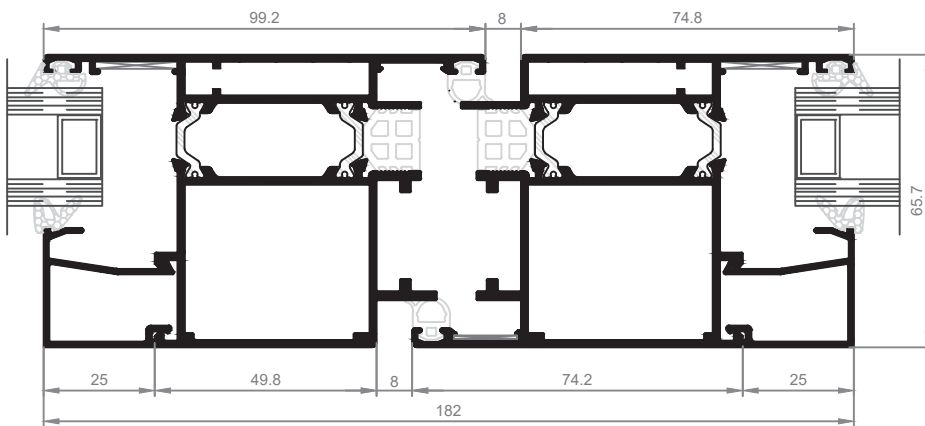

Detalle E

Variante sin pisadera

Con perfil suelo 24658

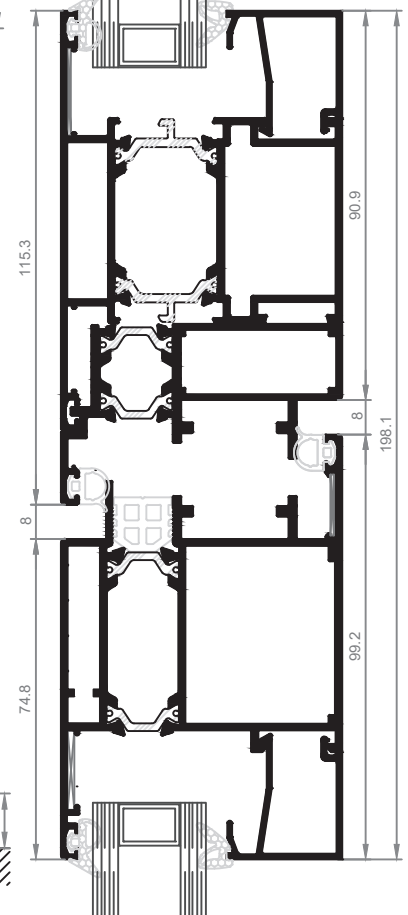
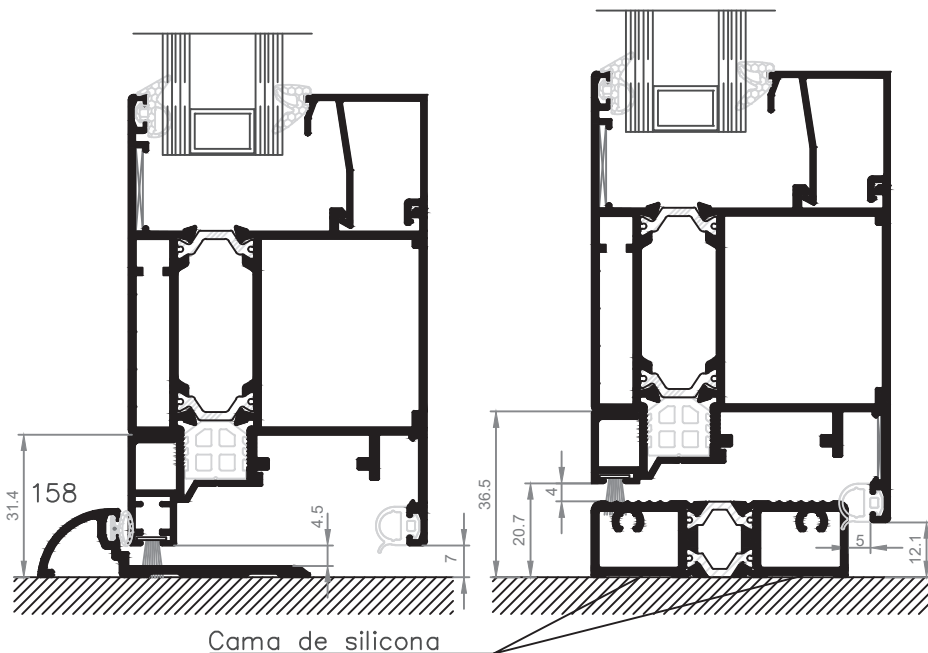

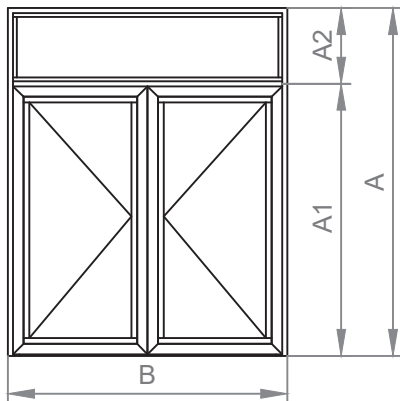

Puerta 2 Hojas+Fijo Superior
Apertura Interior

Acristalamiento		
Uds.	Alto	Ancho
2	A1-234	(B-454)/2
1	A2-78	B-83

Nota:

- (1) Ver tabla acristalamiento.
- (2) Consultar diferentes modelos en catálogo.

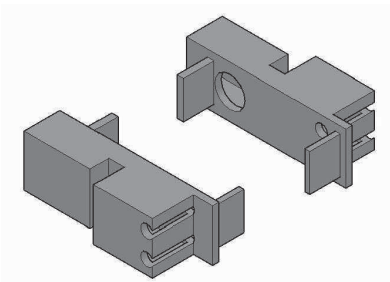

**Juego tapones pisadera
(opcional)
TP6910802**

Pos	Uds.	Nt.	Referencia	Croquis	Denominación	Corte	Longitud en m/m.
Marco	1		24001		Marco	45° 90°	A
	1		24001		Marco	90° 45°	A
	1		24001		Marco	45° 45°	B
	1		24640		Conversor	45° 90°	A1-24
	1		24640		Conversor	90° 45°	A1-24
	1		24640		Conversor	45° 45°	B-57
	1		24023		Travesaño Puerta	90° 90°	B-47
Hoja	3		24622		Hoja Puerta	45° 45°	A1-62
	1		24623		Inversor Ap. Interior	45° 45°	A1-62
	4		24622		Hoja Puerta	45° 45°	(B-92)/2
	2		24643		Terminal Hoja	90° 90°	(B-190)/2
	1		24658		Perfil Inferior	90° 90°	B-92
	2	(1)	Ver nota		Junquillo	90° 90°	A2-102
	2	(1)	Ver nota		Junquillo	90° 90°	B-57
	4	(1)	Ver nota		Junquillo	90° 90°	A1-260
4	(1)	Ver nota		Junquillo	90° 90°	(B-402)/2	

Pos	Uds.	Nt.	Referencia	Denominación
Accesorios	2		E030200	Escuadra Bloqueo Marco
	2		E1010200	Escuadra Bloqueo exterior Marco
	2		E1049500	Escuadra Alineamiento exterior Marco
	2		E1250200	Escuadra Bloqueo Conversor
	8		E1250200+E1240000	Escuadra Bloqueo Hoja
	8		E1270900	Escuadra Balín Hoja
	8		E1009500	Escuadra Alineamiento interior hoja
	8		E630900	Escuadra Alineamiento exterior hoja
	6	(2)	B5741XX	Bisagra Puerta
	1	(2)	V13570XX	Juego Manilla Puerta
	1	(2)		Cerradura
	2		V2744100	Pasador puerta 250mm
	1		V2754100	Cerradero superior marco pasador
	1		V227400	Cerradero inferior suelo pasador
	4		E1079500	Pieza refuerzo unión Travesaño-Marco
	2		E230200	Unión travesaño puerta 35mm
	1		TP6310800	Juego tapones bajo puerta para 24642
	Juntas	6A1+3B		G787000
4A1+2B			G797000	Junta Tapa Canal
1B			VC51	Cepillo inferior 7x6
4A+4B		(1)		Goma Exterior acristalar
4A+4B		(1)		Goma Interior acristalar

**PUERTA 2H. PRACTICABLES APERTURA EXTERIOR
CON MONTANTE FIJO**

Detalle C

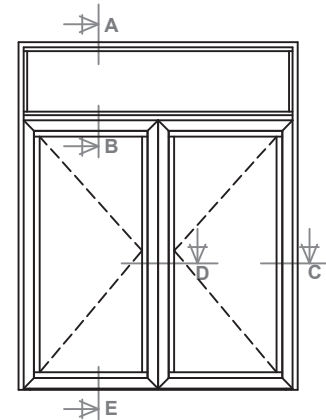
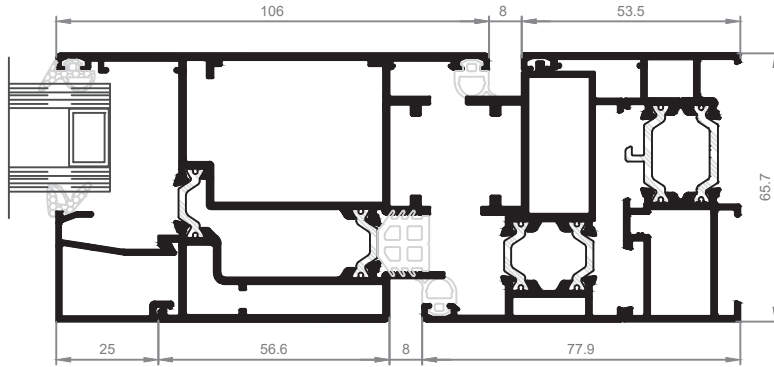

Sección A-B

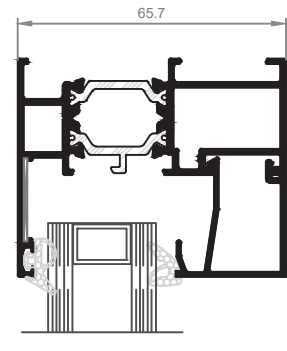

Detalle D

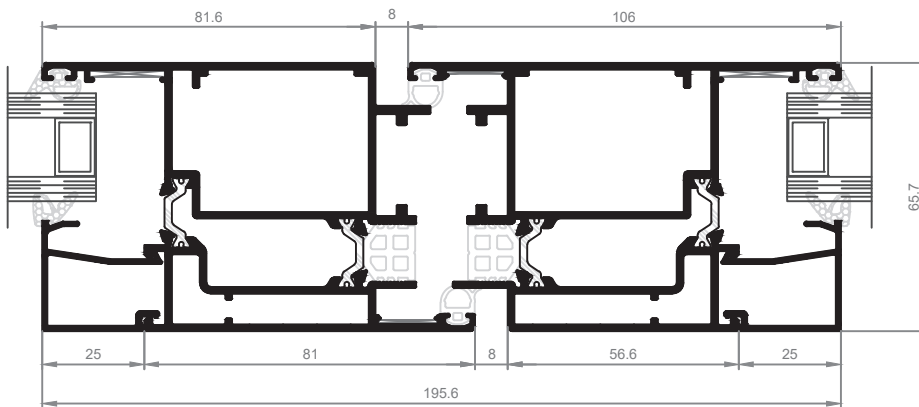

Detalle E

Variante sin pisadera

Con perfil suelo 24658

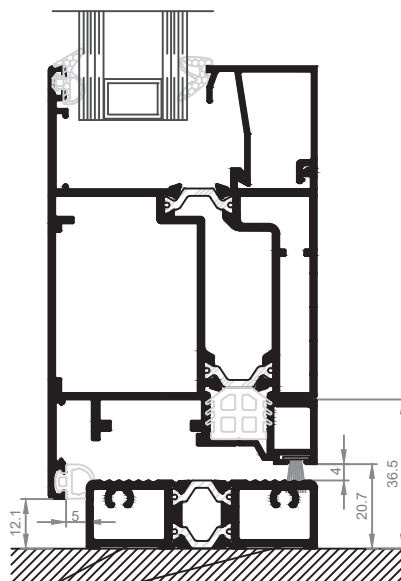
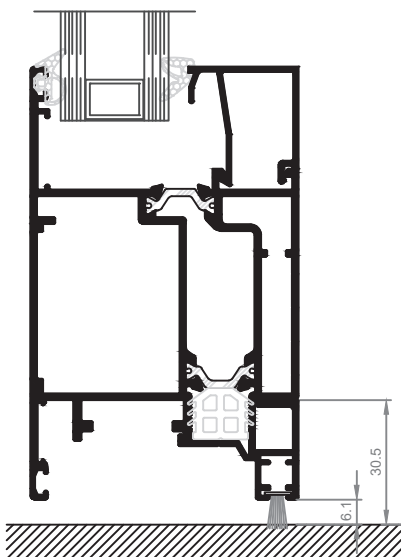

Cama de silicona

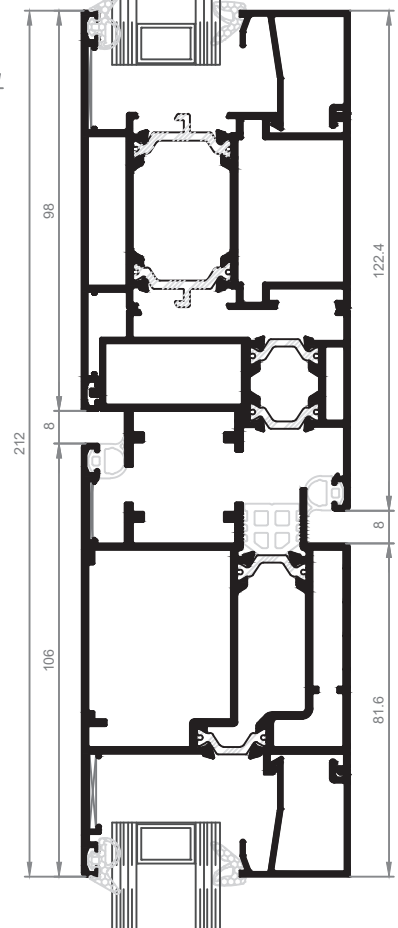

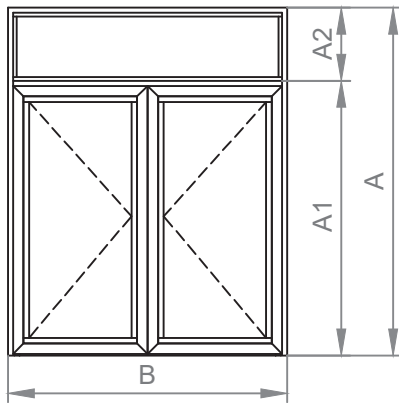

Acristalamiento		
Uds.	Alto	Ancho
1	A2-78	B-83
2	A1-257	(B-482)/2

Nota:

- (1) Ver tabla acristalamiento.
- (2) Consultar diferentes modelos en catálogo.

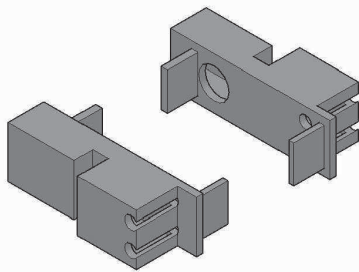

**Juego tapones pisadera
(opcional)
TP6910802**

Puerta 2 Hojas+Fijo Superior Apertura Exterior

Pos	Uds.	Nt.	Referencia	Croquis	Denominación	Corte	Longitud en m/m.
Marco	1		24001		Marco	45° 90°	A
	1		24001		Marco	90° 45°	A
	1		24001		Marco	45° 45°	B
	1		24650		Conversor	45° 90°	A1-24
	1		24650		Conversor	90° 45°	A1-24
	1		24650		Conversor	45° 45°	B-57
	1		24023		Travesaño Puerta	90° 90°	B-47
Hoja	3		24628		Hoja Puerta	45° 45°	A1-69
	1		24629		Inversor Ap. Exterior	45° 45°	A1-69
	4		24628		Hoja Puerta	45° 45°	(B-107)/2
	2		24643		Terminal Hoja	90° 90°	(B-204)/2
	1		24658		Perfil Inferior	90° 90°	B-107
	2	(1)	Ver nota		Junquillo	90° 90°	A2-102.5
	2	(1)	Ver nota		Junquillo	90° 90°	B-57
	4	(1)	Ver nota		Junquillo	90° 90°	A1-281
4	(1)	Ver nota		Junquillo	90° 90°	(B-430)/2	

Pos	Uds.	Nt.	Referencia	Denominación	
Accesorios	2		E030200	Escuadra Bloqueo Marco	
	2		E1010200	Escuadra Bloqueo exterior Marco	
	2		E1049500	Escuadra Alineamiento exterior Marco	
	2		E1250200	Escuadra Bloqueo Conversor	
	8		E1250200+E1240000	Escuadra Bloqueo Hoja	
	8		E1270900	Escuadra Balín Hoja	
	8		E1009500	Escuadra Alineamiento interior hoja	
	8		E630900	Escuadra Alineamiento exterior hoja	
	6	(2)	B5741XX	Bisagra Puerta	
	1	(2)	V13570XX	Juego Manilla Puerta	
	1	(2)		Cerradura	
	2		V2744100	Pasador puerta 250mm	
	1		V2754100	Cerradero superior marco pasador	
	1		V227400	Cerradero inferior suelo pasador	
	4		E1079500	Pieza refuerzo unión Travesaño-Marco	
	2		E230200	Unión travesaño puerta 35mm	
	1		TP6310800	Juego tapones bajo puerta para 24642	
	Juntas	6A1+3B		G787000	Junta Batiente
		4A1+2B		G797000	Junta Tapa Canal
1B			VC51	Cepillo inferior 7x6	
4A+4B		(1)		Goma Exterior acristalar	
4A+4B		(1)		Goma Interior acristalar	

PUERTA 2H. PRACTICABLES APERTURA INTERIOR CON FIJO LATERAL

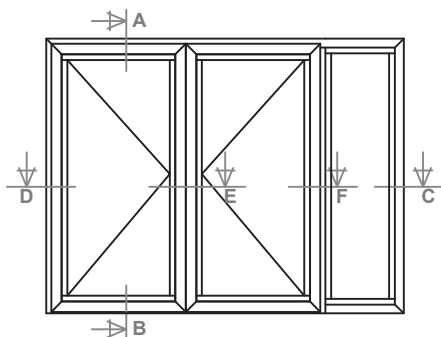

Sección A-B

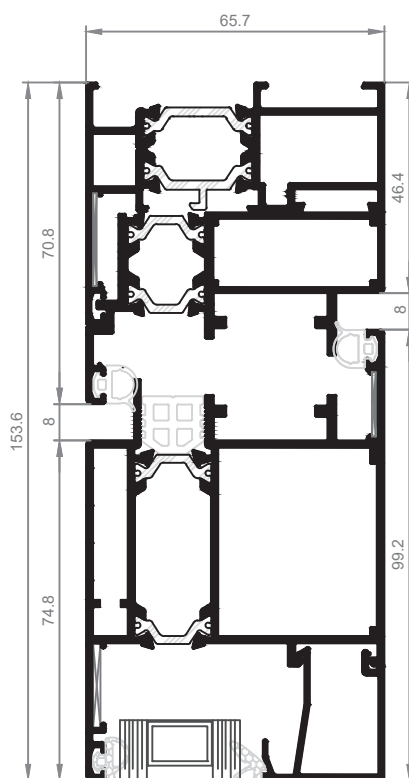

Variante sin pisadera

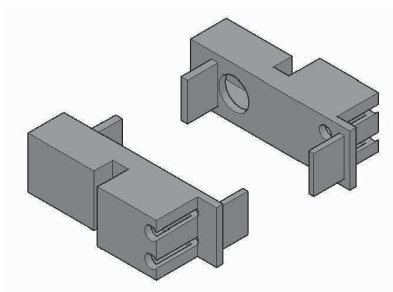
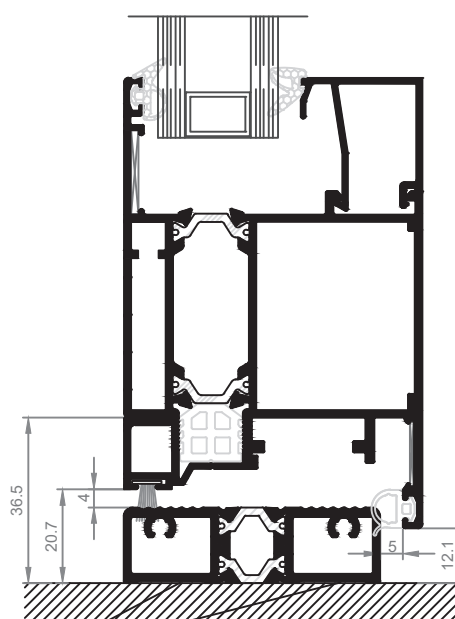
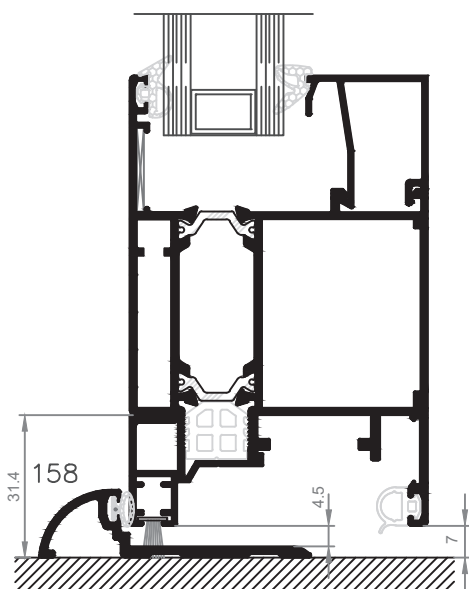

**Juego tapones pisadera
(opcional)
TP6910802**

Cama de silicona

PUERTA 2H. PRACTICABLES APERTURA INTERIOR CON FIJO LATERAL

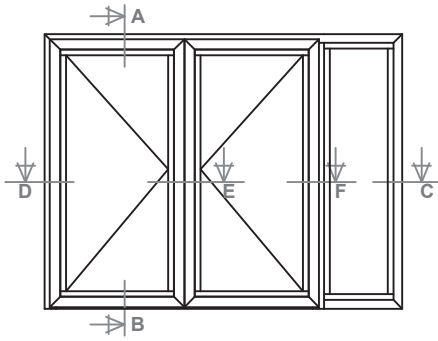

Detalle D

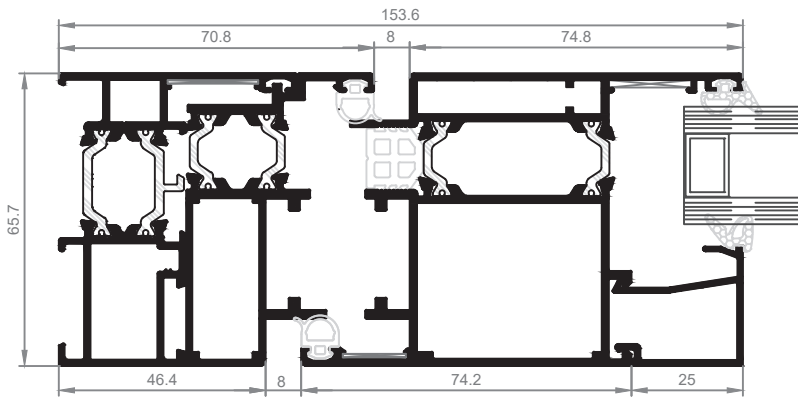

Detalle C

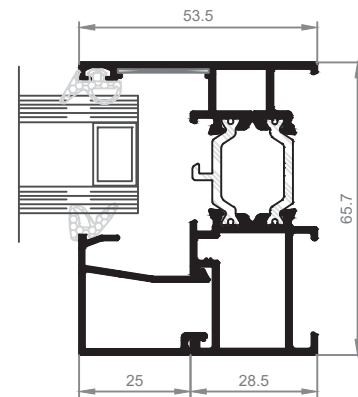

Detalle E

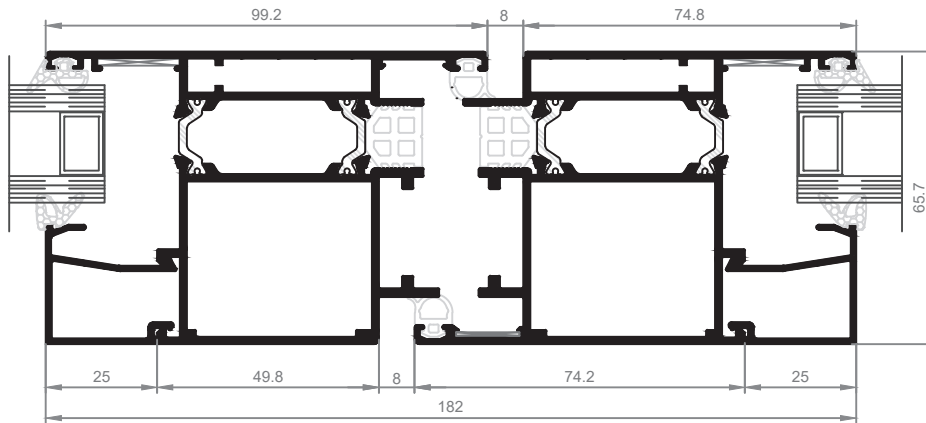

Detalle F

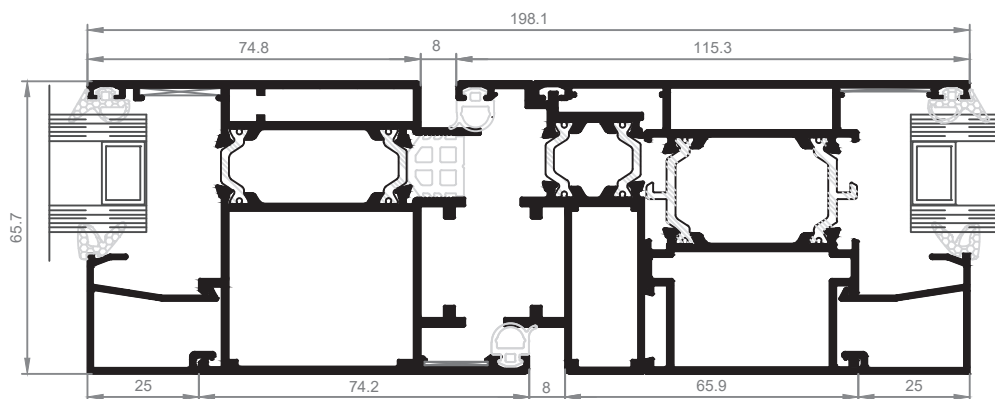

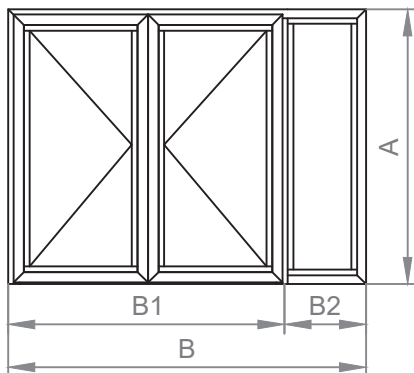

Puerta 2 Hojas+Fijo Lateral
Apertura Interior

Acristalamiento		
Uds.	Alto	Ancho
1	A-83	B2-78
2	A-241	(B1-437)/2

Nota:

- (1) Ver tabla acristalamiento.
- (2) Consultar diferentes modelos en catálogo.

Pos	Uds.	Nt.	Referencia	Croquis	Denominación	Corte	Longitud en m/m.
Marco	1		24001		Marco	45° 45°	A
	1		24001		Marco	90° 45°	A
	1		24001		Marco	45° 45°	B
	1		24001		Marco	45° 90°	B2-19
	1		24640		Convertor	45° 90°	A-28.5
	1		24640		Convertor	90° 45°	A-28.5
	1		24640		Convertor	45° 45°	B1-52.5
	1		24023		Travesaño Puerta	90° 90°	A-23.5
Hoja	3		24622		Hoja Puerta	45° 45°	A-66.5
	1		24623		Inversor Ap. Interior	45° 45°	A-66.5
	4		24622		Hoja Puerta	45° 45°	(B1-88)/2
	2		24643		Terminal Hoja	90° 90°	(B1-186)/2
	1		24658		Perfil Inferior	90° 90°	B1-88
	2	(1)	Ver nota		Junquillo	90° 90°	A-107
	2	(1)	Ver nota		Junquillo	90° 90°	B2-52
	4	(1)	Ver nota		Junquillo	90° 90°	A-265
4	(1)	Ver nota		Junquillo	90° 90°	(B1-385)/2	

Pos	Uds.	Nt.	Referencia	Denominación
Accesorios	2		E1260200	Escuadra Bloqueo Marco
	2		E1010200	Escuadra Bloqueo exterior Marco
	2		E1049500	Escuadra Alineamiento exterior Marco
	2		E1250200	Escuadra Bloqueo Convertor
	8		E1250200+E1240000	Escuadra Bloqueo Hoja
	8		E1270900	Escuadra Balín Hoja
	8		E1009500	Escuadra Alineamiento interior hoja
	8		E630900	Escuadra Alineamiento exterior hoja
	6	(2)	B5741XX	Bisagra Puerta
	1	(2)	V13570XX	Juego Manilla Puerta
	1	(2)		Cerradura
	2		V2744100	Pasador puerta 250mm
	1		V2754100	Cerradero superior marco pasador
	1		V227400	Cerradero inferior suelo pasador
	4		E1079500	Pieza refuerzo unión Travesaño-Marco
	2		E230200	Unión travesaño puerta 35mm
	1		TP6310800	Juego tapones bajo puerta para 24642
	Juntas	6A+3B1		G787000
4A+2B1			G797000	Junta Tapa Canal
1B			VC51	Cepillo inferior 7x6
6A+2B		(1)		Goma Exterior acristalar
6A+2B		(1)		Goma Interior acristalar

PUERTA 2H. PRACTICABLES APERTURA EXTERIOR CON FIJO LATERAL

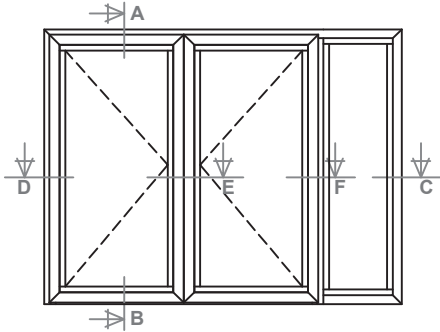

Sección A-B

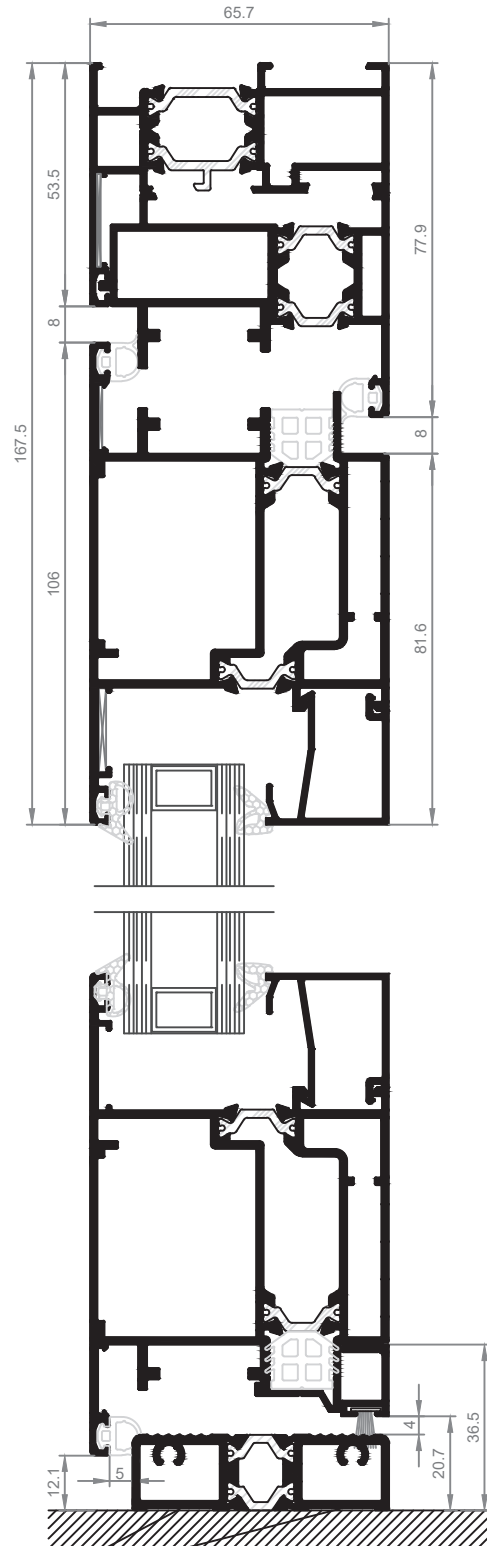

Variante sin pisadera

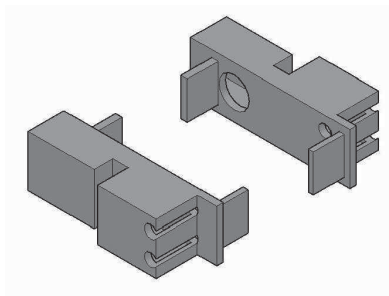
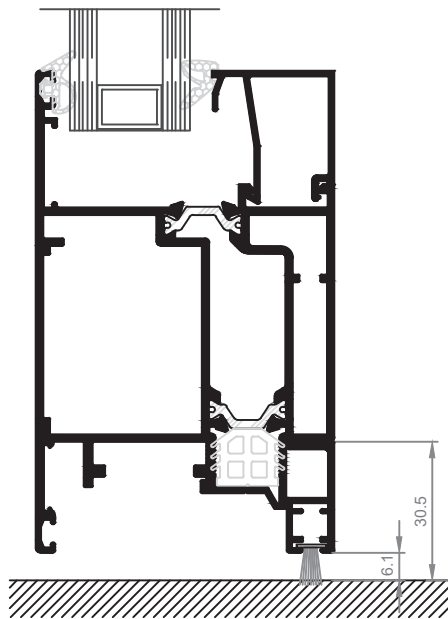

Juego tapones pisadera
(opcional)
TP6910802

Cama de silicona

PUERTA 2H. PRACTICABLES APERTURA EXTERIOR CON MONTANTE FIJO

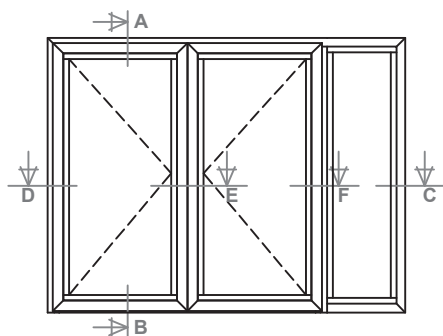

Detalle D

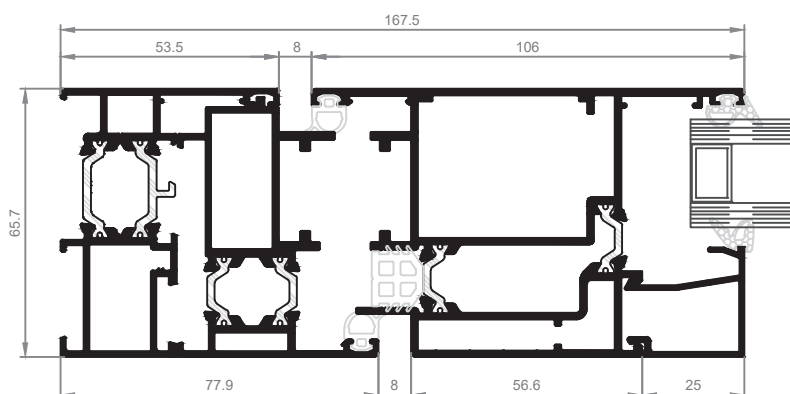

Detalle C

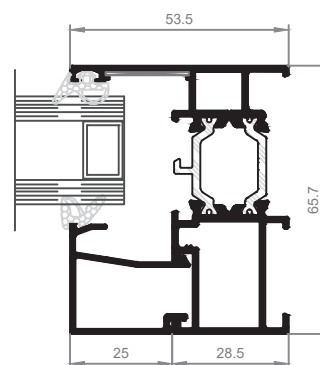

Detalle E

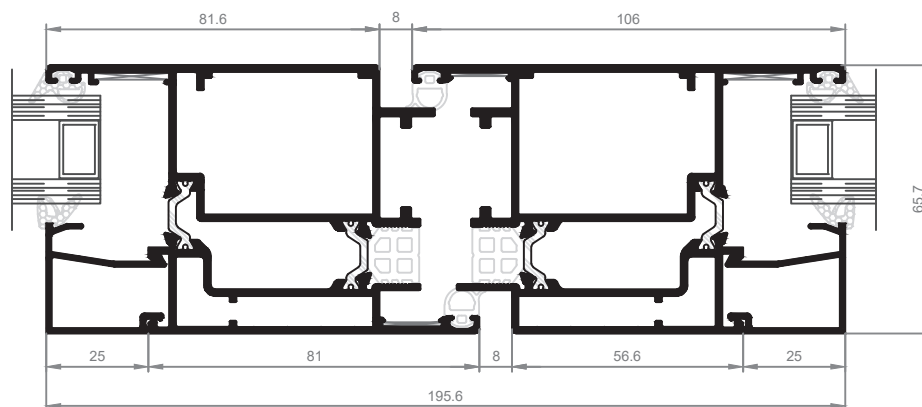

Detalle F

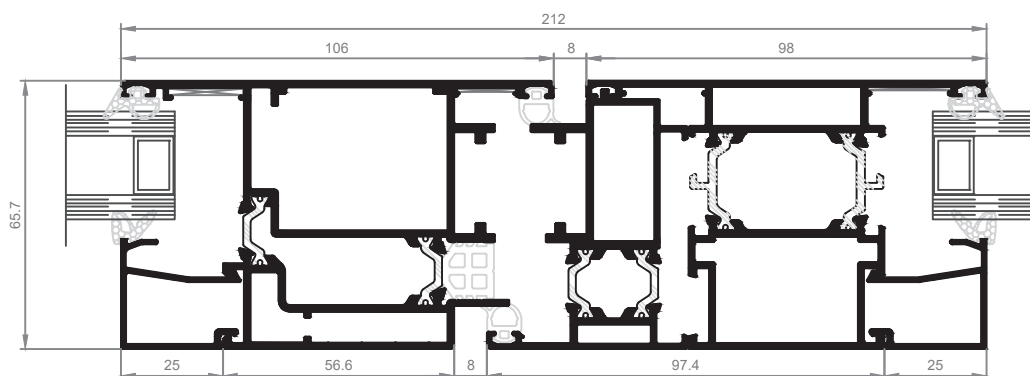

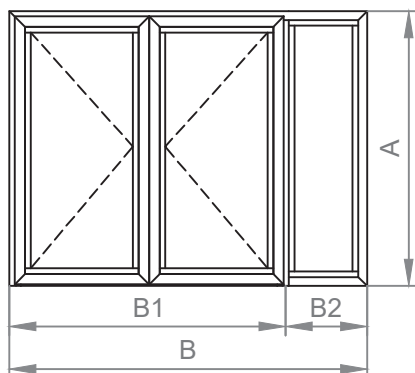

Acristalamiento		
Uds.	Alto	Ancho
1	A-83	B2-78
2	A-262	(B1-478)/2

Nota:

- (1) Ver tabla acristalamiento.
- (2) Consultar diferentes modelos en catálogo.

Puerta 2 Hojas+Fijo Lateral Apertura Exterior

Pos	Uds.	Nt.	Referencia	Croquis	Denominación	Corte	Longitud en m/m.
Marco	1		24001		Marco	45° 45°	A
	1		24001		Marco	90° 45°	A
	1		24001		Marco	45° 45°	B
	1		24001		Marco	45° 90°	B2-19
	1		24650		Convertor	45° 90°	A-28.5
	1		24650		Convertor	90° 45°	A-28.5
	1		24650		Convertor	45° 45°	B1-52.5
	1		24023		Travesaño puerta	90° 90°	A-23.5
Hoja	3		24628		Hoja Puerta	45° 45°	A-74
	1		24629		Inversor Ap. Exterior	45° 45°	A-74
	4		24628		Hoja Puerta	45° 45°	(B1-102)/2
	2		24643		Terminal Hoja	90° 90°	(B1-200)/2
	1		24658		Perfil Inferior	90° 90°	B1-102.5
	2	(1)	Ver nota		Junquillo	90° 90°	A-107
	2	(1)	Ver nota		Junquillo	90° 90°	B2-52
	4	(1)	Ver nota		Junquillo	90° 90°	A-285
4	(1)	Ver nota		Junquillo	90° 90°	(B1-426)/2	

Pos	Uds.	Nt.	Referencia	Denominación
Accesorios	2		E030200	Escuadra Bloqueo Marco
	2		E1010200	Escuadra Bloqueo exterior Marco
	2		E1049500	Escuadra Alineamiento exterior Marco
	2		E1250200	Escuadra Bloqueo Convertor
	8		E1250200+E1240000	Escuadra Bloqueo Hoja
	8		E1270900	Escuadra Balín Hoja
	8		E1009500	Escuadra Alineamiento interior hoja
	8		E630900	Escuadra Alineamiento exterior hoja
	6	(2)	B5741XX	Bisagra Puerta
	1	(2)	V13570XX	Juego Manilla Puerta
	1	(2)		Cerradura
	2		V2744100	Pasador puerta 250mm
	1		V2754100	Cerradero superior marco pasador
	1		V227400	Cerradero inferior suelo pasador
	4		E1079500	Pieza refuerzo unión Travesaño-Marco
	2		E230200	Unión travesaño puerta 35mm
	1		TP6310800	Juego tapones bajo puerta para 24642
	Juntas	6A+3B		G787000
4A+2B1			G797000	Junta Tapa Canal
1B1			VC51	Cepillo inferior 7x6
4A+4B		(1)		Goma Exterior acristalar
4A+4B		(1)		Goma Interior acristalar

PUERTA 1H. PRACTICABLE APERTURA INTERIOR CON MONTANTE FIJO

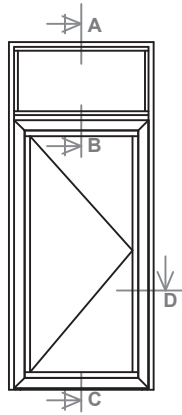

Sección A-B-C

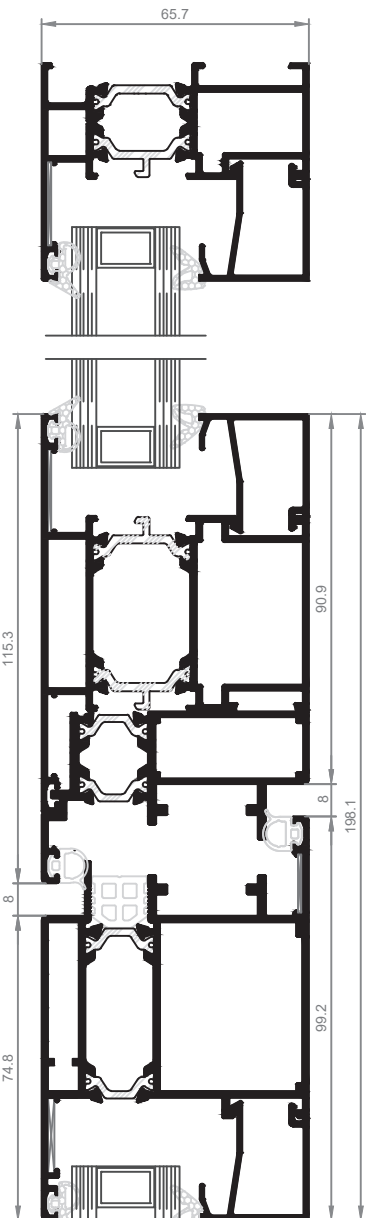

Detalle D

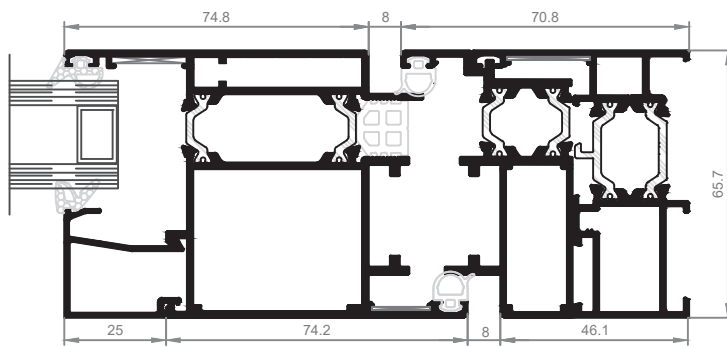

Detalle C

Variante sin pisadera

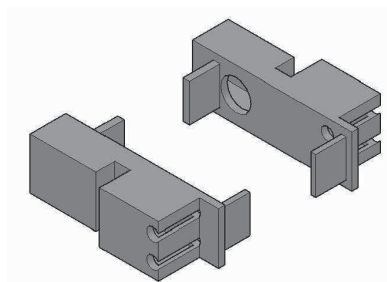
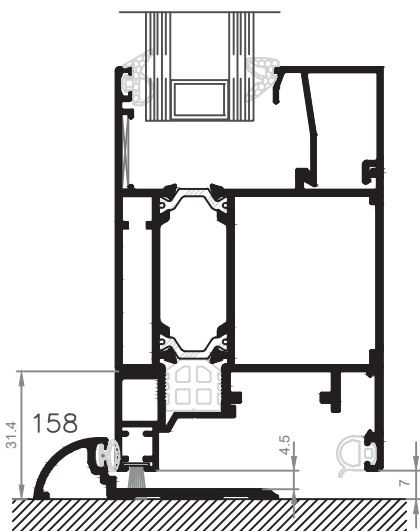

Juego tapones pisadera
(opcional)
TP6910802

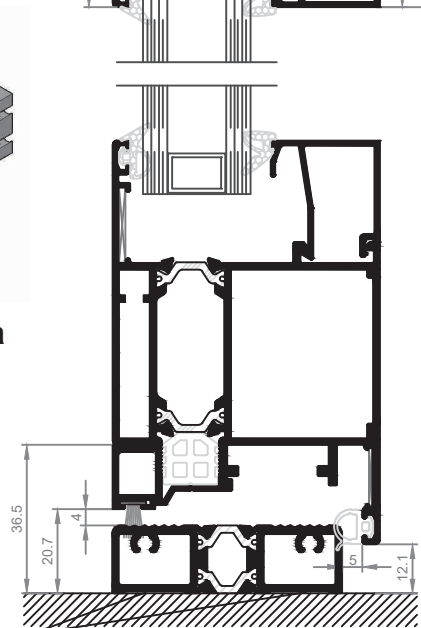

Cama de silicona

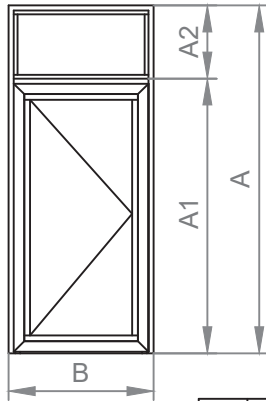

Puerta 1 Hoja+Fijo Superior
Apertura Interior

Acristalamiento		
Uds.	Alto	Ancho
1	A2-78	B-83
1	A1-236	B-283

Nota:

- (1) Ver tabla acristalamiento.
- (2) Consultar diferentes modelos en catálogo.

Pos	Uds.	Nt.	Referencia	Croquis	Denominación	Corte	Longitud en m/m.
Marco	1		24001		Marco	45° 90°	A
	1		24001		Marco	90° 45°	A
	1		24001		Marco	45° 45°	B
	1		24640		Convertor	45° 90°	A1-24
	1		24640		Convertor	90° 45°	A1-24
	1		24640		Convertor	45° 45°	B-57
	1		24023		Travesaño Puerta	90° 90°	B-47
Hoja	2		24622		Hoja Puerta	45° 45°	A1-62
	2		24622		Hoja Puerta	45° 45°	B-109
	1		24643		Terminal Hoja	90° 90°	B-158
	1		24658		Perfil Inferior	90° 90°	B-92
	2	(1)	Ver nota		Junquillo	90° 90°	A2-102.5
	2	(1)	Ver nota		Junquillo	90° 90°	B-57
	2	(1)	Ver nota		Junquillo	90° 90°	A1-260
	2	(1)	Ver nota		Junquillo	90° 90°	B-257

Pos	Uds.	Nt.	Referencia	Denominación
Accesorios	2		E030200	Escuadra Bloqueo Marco
	2		E1010200	Escuadra Bloqueo exterior Marco
	2		E1049500	Escuadra Alineamiento exterior Marco
	2		E1250200	Escuadra Bloqueo Convertor
	4		E1250200+E1240000	Escuadra Bloqueo Hoja
	4		E1270900	Escuadra Balín Hoja
	4		E1009500	Escuadra Alineamiento interior hoja
	4		E630900	Escuadra Alineamiento exterior hoja
	3	(2)	B5741XX	Bisagra Puerta
	1	(2)	V13570XX	Juego Manilla Puerta
	1	(2)		Cerradura
	4		E1079500	Pieza refuerzo unión Travesaño-Marco
	2		E230200	Unión travesaño puerta 35mm
	1		TP6110800	Juego tapones bajo puerta para 24642
	Juntas	4A1+3B		G787000
2A1+2B			G797000	Junta Tapa Canal
1B			VC51	Cepillo inferior 7x6
2A+4B		(1)		Goma Exterior acristalar
2A+4B		(1)		Goma Interior acristalar

**PUERTA 1H. PRACTICABLE APERTURA EXTERIOR
CON MONTANTE FIJO**

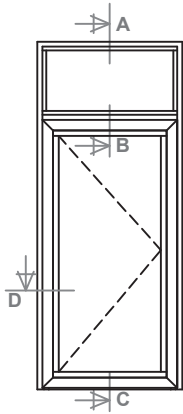

Sección A

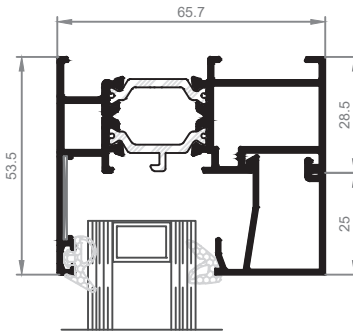

Sección B-C

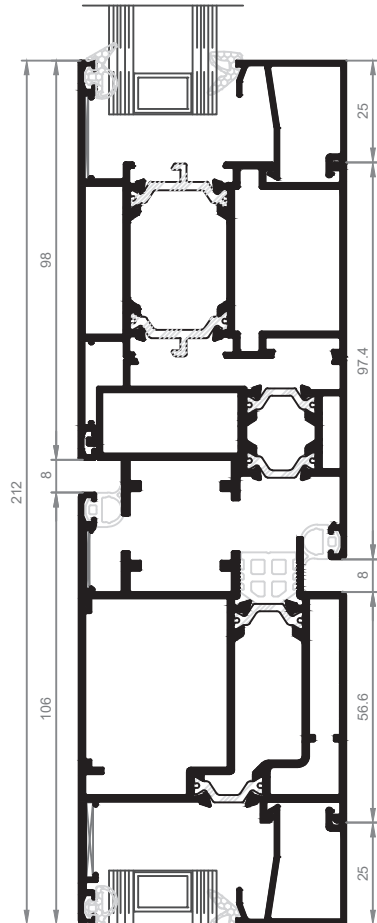

Sección D

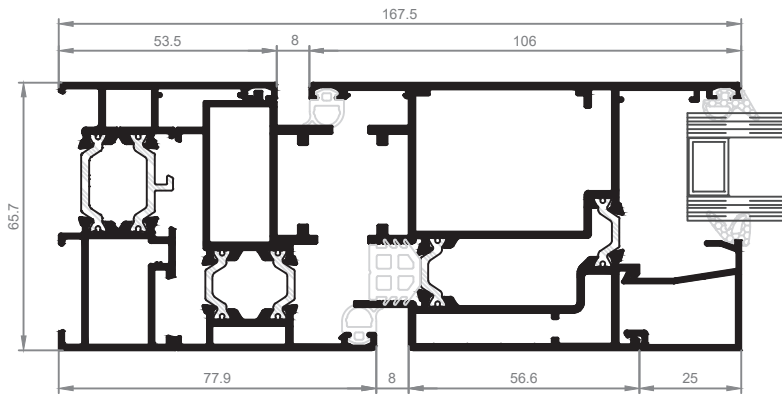

Sección C

Variante sin pisadera

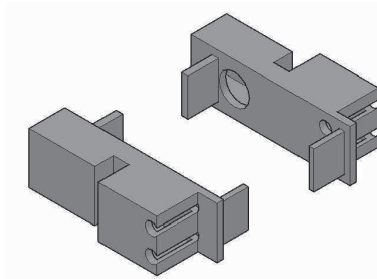
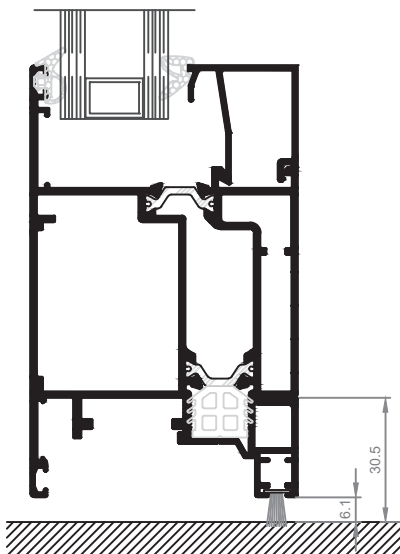

**Juego tapones pisadera
(opcional)
TP6910802**

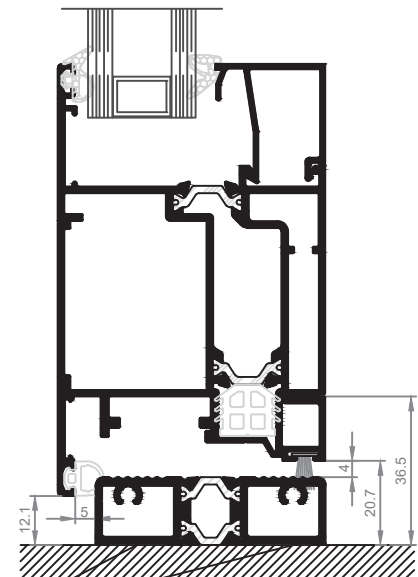

Cama de silicona

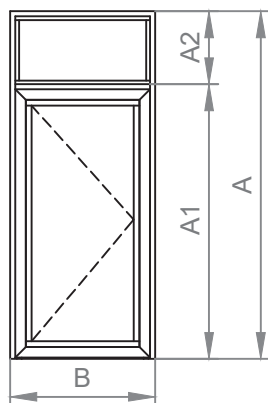

Puerta 1 Hoja+Fijo Superior
Apertura Exterior

Acristalamiento		
Uds.	Alto	Ancho
1	A2-76	B-83
1	A1-255	B-308

Nota:

(1) Ver tabla acristalamiento.

(2) Consultar diferentes modelos en catálogo.

Pos	Uds.	Nt.	Referencia	Croquis	Denominación	Corte	Longitud en m/m.
Marco	1		24001		Marco	45° 90°	A
	1		24001		Marco	90° 45°	A
	1		24001		Marco	45° 45°	B
	1		24650		Convertor	45° 90°	A1-24
	1		24650		Convertor	90° 45°	A1-24
	1		24650		Convertor	45° 45°	B-57
	1		24023		Travesaño puerta	90° 90°	B-47
Hoja	2		24628		Hoja Puerta	45° 45°	A1-69
	2		24628		Hoja Puerta	45° 45°	B-123
	1		24643		Terminal Hoja	90° 90°	B-172
	1		24658		Perfil Inferior	90° 90°	B-107
	2	(1)	Ver nota		Junquillo	90° 90°	A2-102.5
	2	(1)	Ver nota		Junquillo	90° 90°	B-57
	2	(1)	Ver nota		Junquillo	90° 90°	A1-281
	2	(1)	Ver nota		Junquillo	90° 90°	B-285

Pos	Uds.	Nt.	Referencia	Denominación
Accesorios	2		E030200	Escuadra Bloqueo Marco
	2		E1010200	Escuadra Bloqueo exterior Marco
	2		E1049500	Escuadra Alineamiento exterior Marco
	2		E1250200	Escuadra Bloqueo Convertor
	4		E1250200+E1240000	Escuadra Bloqueo Hoja
	4		E1270900	Escuadra Balín Hoja
	4		E1009500	Escuadra Alineamiento interior hoja
	4		E630900	Escuadra Alineamiento exterior hoja
	3	(2)	B5741XX	Bisagra Puerta
	1	(2)	V13570XX	Juego Manilla Puerta
	1	(2)		Cerradura
	4		E1079500	Pieza refuerzo unión Travesaño-Marco
	2		E230200	Unión travesaño puerta 35mm
	1		TP6110800	Juego tapones bajo puerta para 24642
	Juntas	4A1+3B		G787000
2A1+2B			G797000	Junta Tapa Canal
1B			VC51	Cepillo inferior 7x6
2A+4B		(1)		Goma Exterior acristalar
2A+4B		(1)		Goma Interior acristalar

**PUERTA 1H. PRACTICABLES APERTURA INTERIOR
CON FIJO LATERAL**

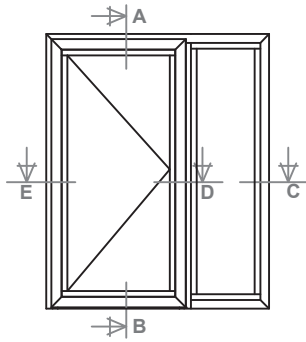

Sección A-B

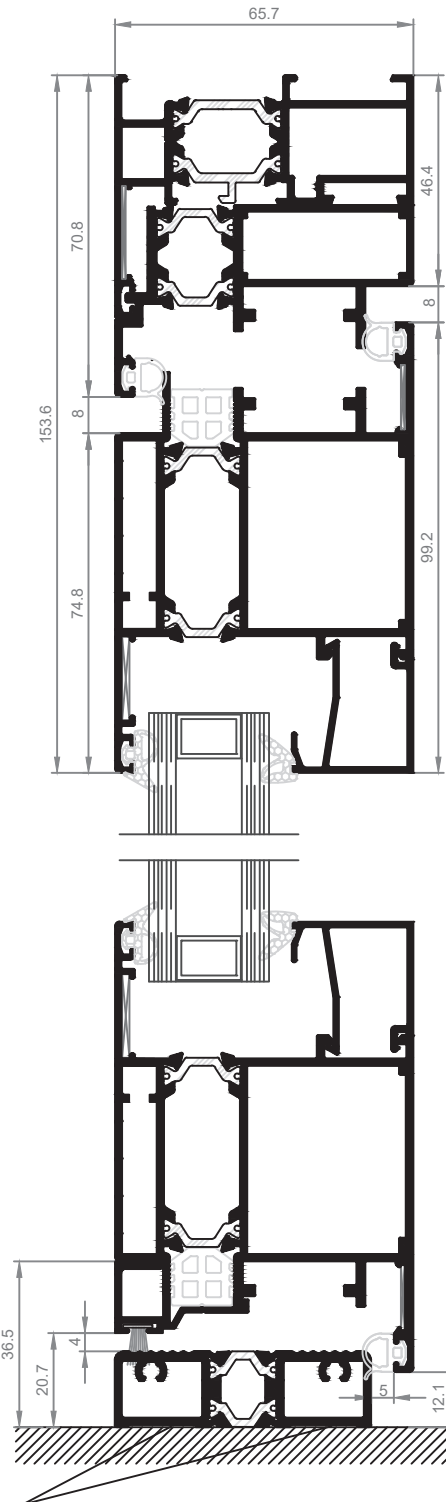

Variante sin pisadera

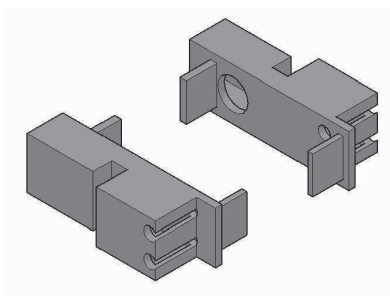
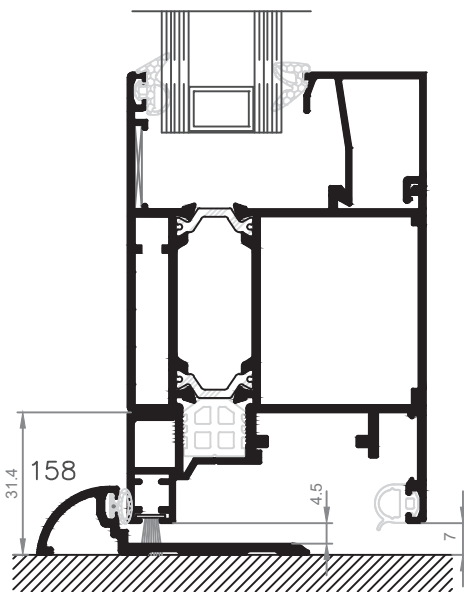

**Juego tapones pisadera
(opcional)
TP6910802**

Cama de silicona

**PUERTA 1H. PRACTICABLES APERTURA INTERIOR
CON FIJO LATERAL**

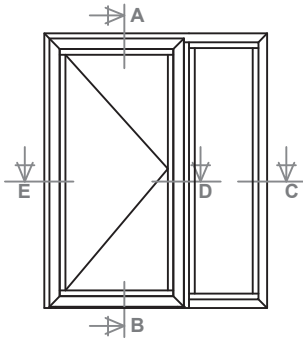

Detalle C-D

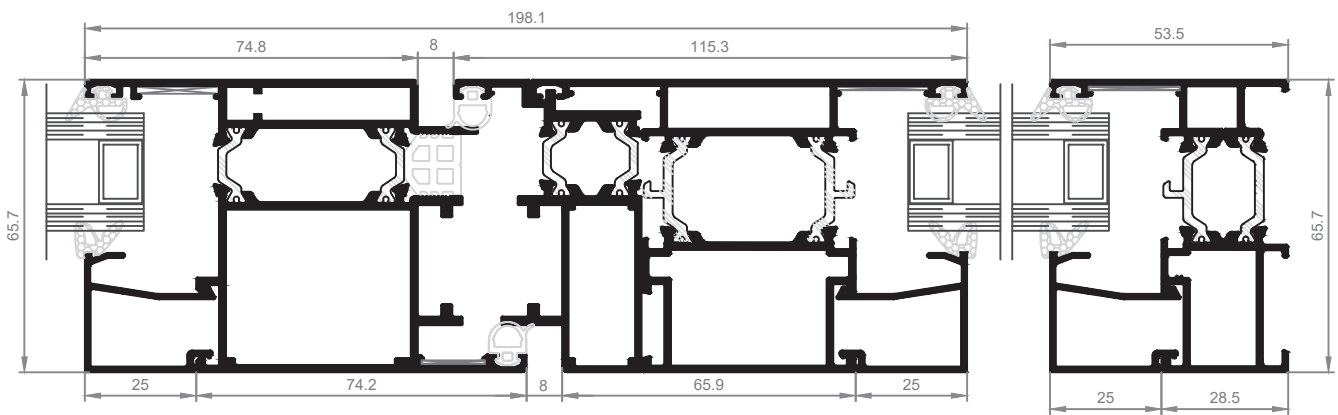

Detalle E

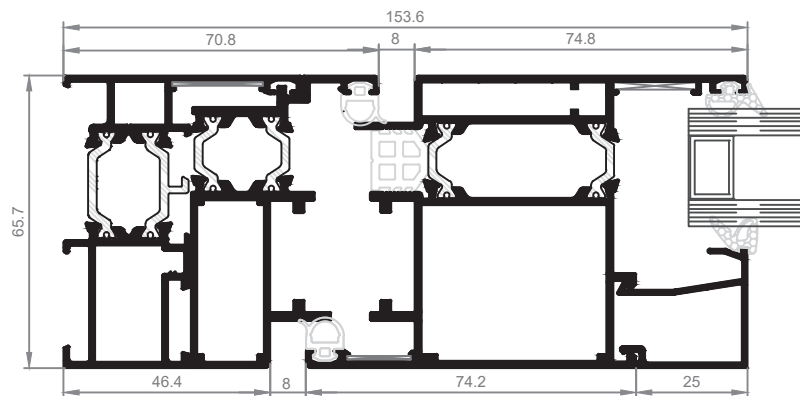

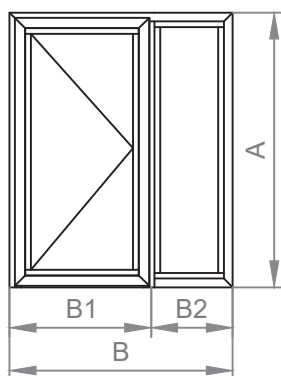













Puerta 1 Hoja+Fijo Lateral
Apertura Interior

Acristalamiento		
Uds.	Alto	Ancho
1	A-83	B2-78
1	A-241	B1-279

Nota:

- (1) Ver tabla acristalamiento.
- (2) Consultar diferentes modelos en catálogo.

Pos	Uds.	Nt.	Referencia	Croquis	Denominación	Corte	Longitud en m/m.
Marco	1		24001		Marco	90° 45°	A
	1		24001		Marco	45° 45°	A
	1		24001		Marco	45° 45°	B
	1		24001		Marco	45° 90°	B2-19
	1		24640		Convertor	45° 90°	A-28.5
	1		24640		Convertor	90° 45°	A-28.5
	1		24640		Convertor	45° 45°	B1-53
	1		24023		Travesaño Puerta	90° 90°	A-23.5
Hoja	2		24622		Hoja Puerta	45° 45°	A-67
	2		24622		Hoja Puerta	45° 45°	B1-104
	1		24643		Terminal Hoja	90° 90°	B-153
	1		24658		Perfil Inferior	90° 90°	B-88
	2	(1)	Ver nota		Junquillo	90° 90°	B2-52
	2	(1)	Ver nota		Junquillo	90° 90°	A-107
	2	(1)	Ver nota		Junquillo	90° 90°	B1-253
	2	(1)	Ver nota		Junquillo	90° 90°	A-265

Pos	Uds.	Nt.	Referencia	Denominación
Accesorios	2		E030200	Escuadra Bloqueo Marco
	2		E1010200	Escuadra Bloqueo exterior Marco
	2		E1049500	Escuadra Alineamiento exterior Marco
	2		E1250200	Escuadra Bloqueo Convertor
	4		E1250200+E1240000	Escuadra Bloqueo Hoja
	4		E1270900	Escuadra Balín Hoja
	4		E1009500	Escuadra Alineamiento interior hoja
	3	(2)	B5741XX	Bisagra Puerta
	1	(2)	V13570XX	Juego Manilla Puerta
	1	(2)		Cerradura
	4		E1079500	Pieza refuerzo unión Travesaño-Marco
	2		E230200	Unión travesaño puerta 35mm
	1		TP6110800	Juego tapones bajo puerta para 24642
	Juntas	4A+3B1		G787000
2A+2B1			G797000	Junta Tapa Canal
1B			VC51	Cepillo inferior 7x6
4A+2B		(1)		Goma Exterior acristalar
4A+2B		(1)		Goma Interior acristalar

PUERTA 1H. PRACTICABLE APERTURA EXTERIOR CON FIJO LATERAL

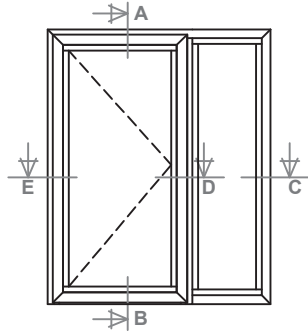

Variante sin pisadera

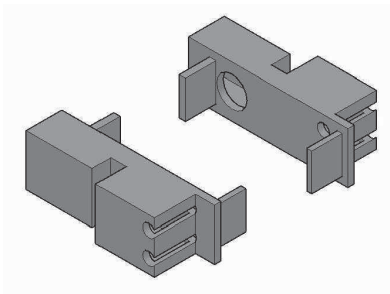
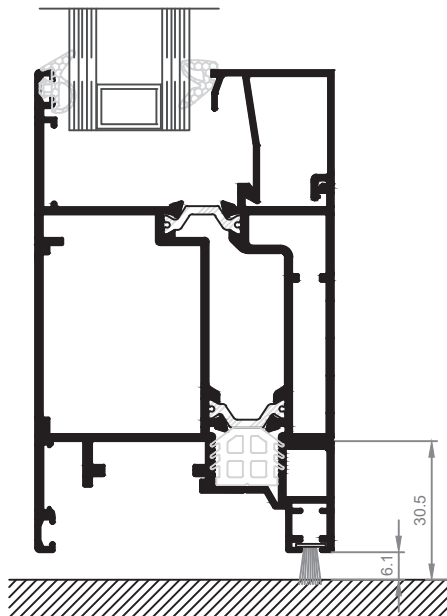

**Juego tapones pisadera
(opcional)
TP6910802**

Sección A-B

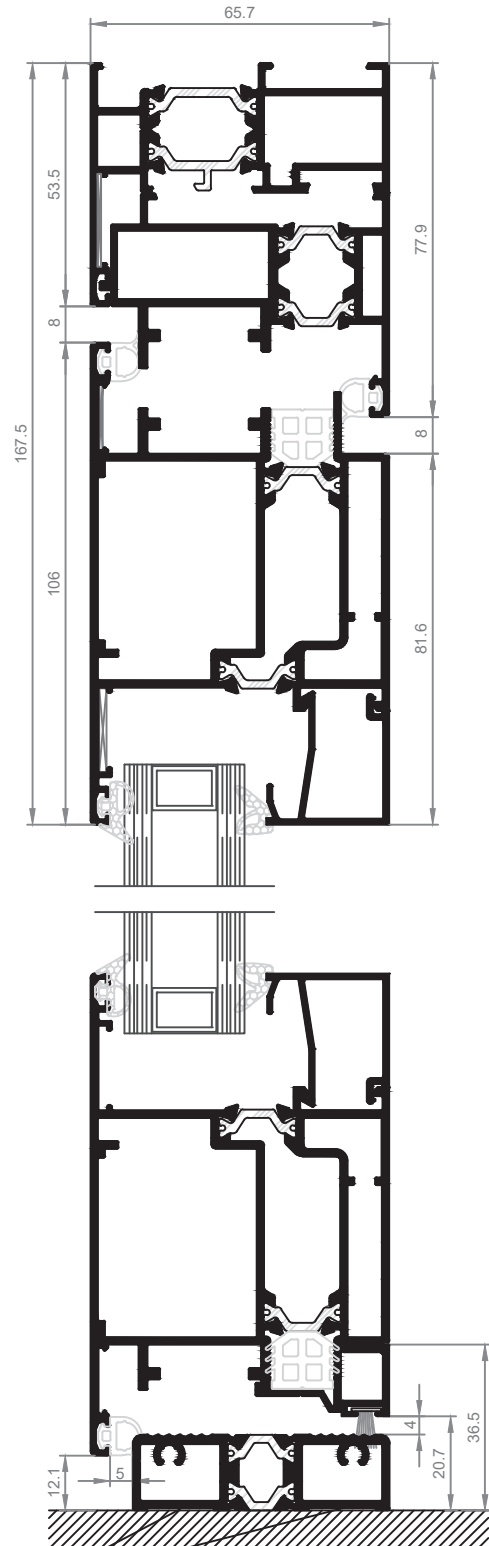

Cama de silicona

**PUERTA 1H. PRACTICABLE APERTURA EXTERIOR
CON FIJO LATERAL**

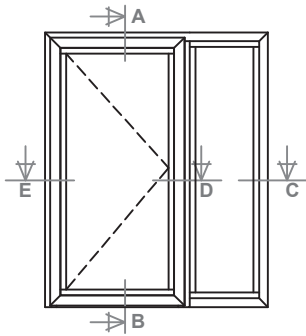

Detalle C-D

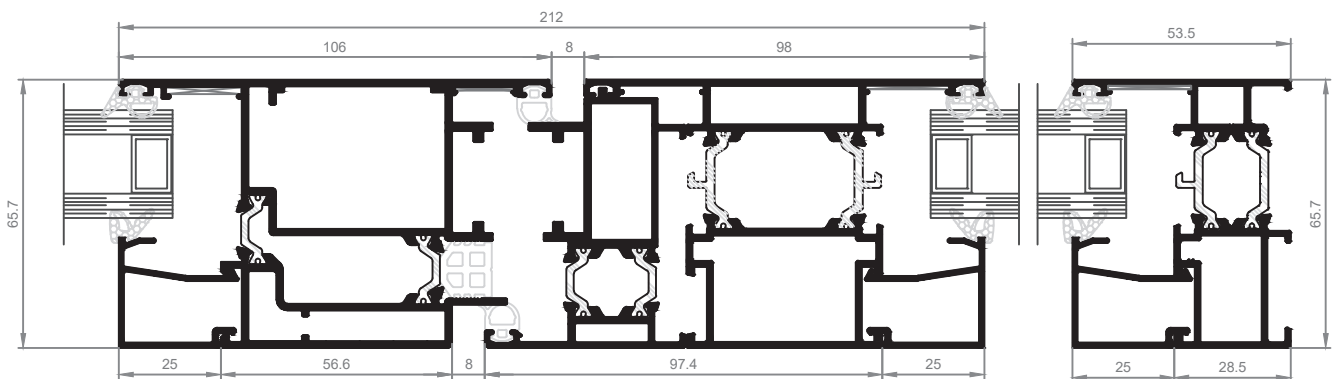

Detalle E

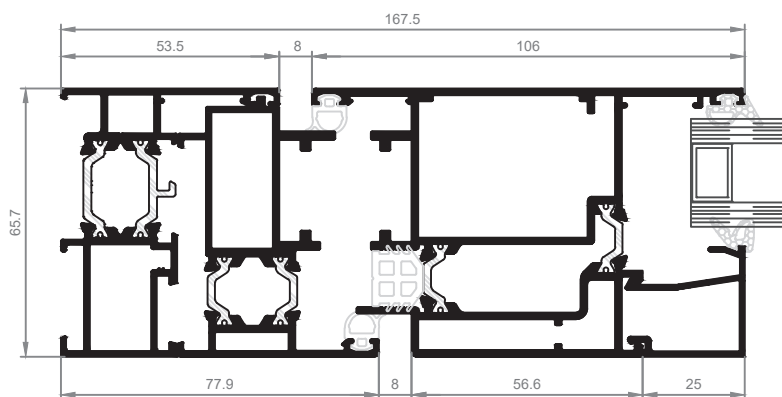

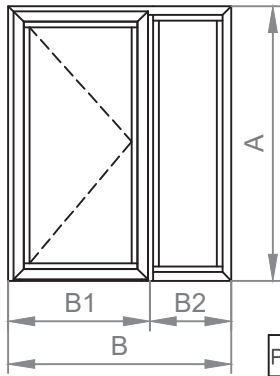

Puerta 1 Hoja+Fijo Lateral
Apertura Exterior

Acristalamiento		
Uds.	Alto	Ancho
1	A1-83	B2-78
1	A-261	B1-306

Nota:

- (1) Ver tabla acristalamiento.
(2) Consultar diferentes modelos en catálogo.

Pos	Uds.	Nt.	Referencia	Croquis	Denominación	Corte	Longitud en m/m.
Marco	1		24001		Marco	90° 45°	A
	1		24001		Marco	45° 45°	A
	1		24001		Marco	45° 45°	B
	1		24001		Marco	45° 90°	B2-19
	1		24650		Conversor	45° 90°	A-28.5
	1		24650		Conversor	90° 45°	A-28.5
	1		24650		Conversor	45° 45°	B1-53
	1		24023		Travesaño puerta	90° 90°	A-23.5
Hoja	2		24628		Hoja Puerta	45° 45°	A-74
	2		24628		Hoja Puerta	45° 45°	B1-118.5
	1		24643		Terminal Hoja	90° 90°	B-167
	1		24658		Perfil Inferior	90° 90°	B-102.5
	2	(1)	Ver nota		Junquillo	90° 90°	A-107
	2	(1)	Ver nota		Junquillo	90° 90°	B2-52.5
	2	(1)	Ver nota		Junquillo	90° 90°	A-285
2	(1)	Ver nota		Junquillo	90° 90°	B1-280.5	

Pos	Uds.	Nt.	Referencia	Denominación
Accesorios	2		E030200	Escuadra Bloqueo Marco
	2		E1010200	Escuadra Bloqueo exterior Marco
	2		E1049500	Escuadra Alineamiento exterior Marco
	2		E1250200	Escuadra Bloqueo Conversor
	4		E1250200+E1240000	Escuadra Bloqueo Hoja
	4		E1270900	Escuadra Balín Hoja
	4		E1009500	Escuadra Alineamiento interior hoja
	4		E630900	Escuadra Alineamiento exterior hoja
	3	(2)	B5741XX	Bisagra Puerta
	1	(2)	V13570XX	Juego Manilla Puerta
	1	(2)		Cerradura
	4		E1079500	Pieza refuerzo unión Travesaño-Marco
	2		E230200	Unión travesaño puerta 35mm
	1		TP6110800	Juego tapones bajo puerta para 24642
Juntas	4A+3B1		G787000	Junta Batiente
	2A+2B1		G797000	Junta Tapa Canal
	1B		VC51	Cepillo inferior 7x6
	4A+2B	(1)		Goma Exterior acristalar
	4A+2B	(1)		Goma Interior acristalar



E630900
Escuadra Alineamiento Fuji
Fijación Hoja

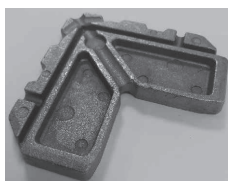

E1270900
Escuadra Balín
marco puerta y hoja



E1280900
Escuadra Balín marco
ventana

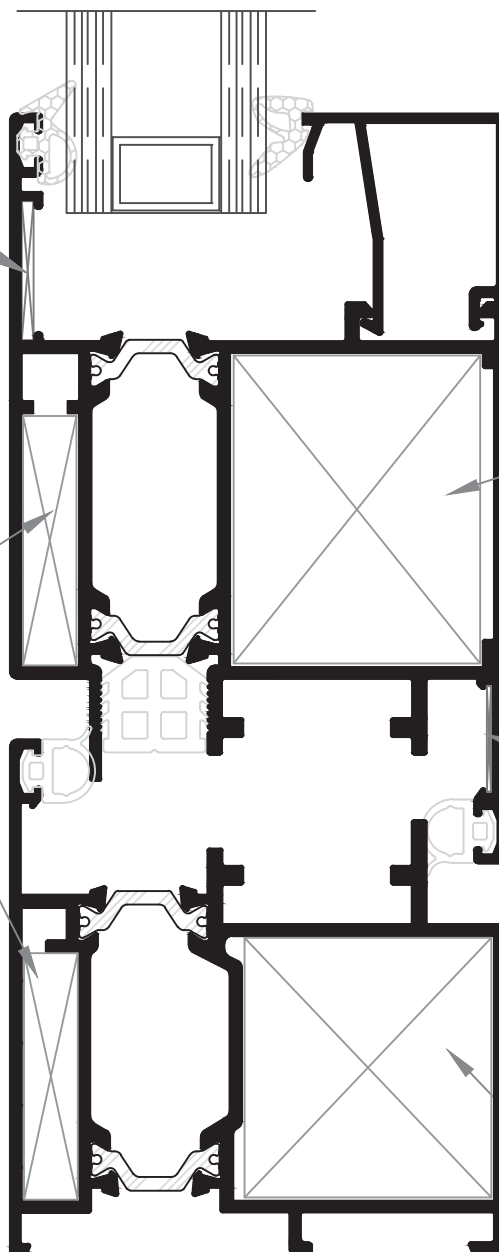

E1250200
Escuadra Bloqueo
hoja

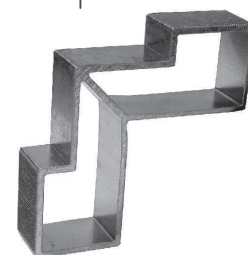

E1240000
Escuadra Universal
hoja



E1009500
Escuadra Alineamiento
Interior Hoja

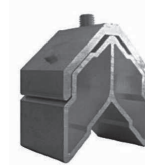

E1260200
Escuadra Bloqueo
marco puerta



E1250200
Escuadra Bloqueo
marco ventana

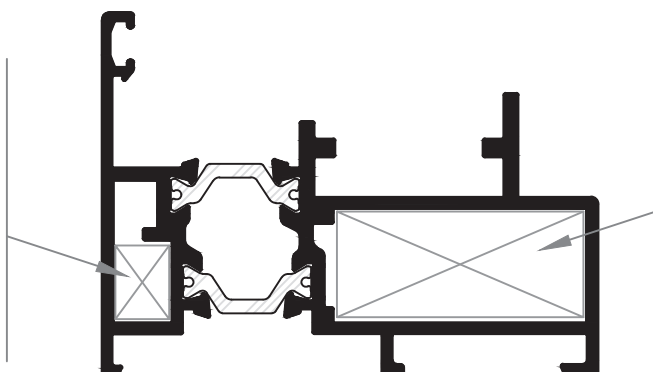

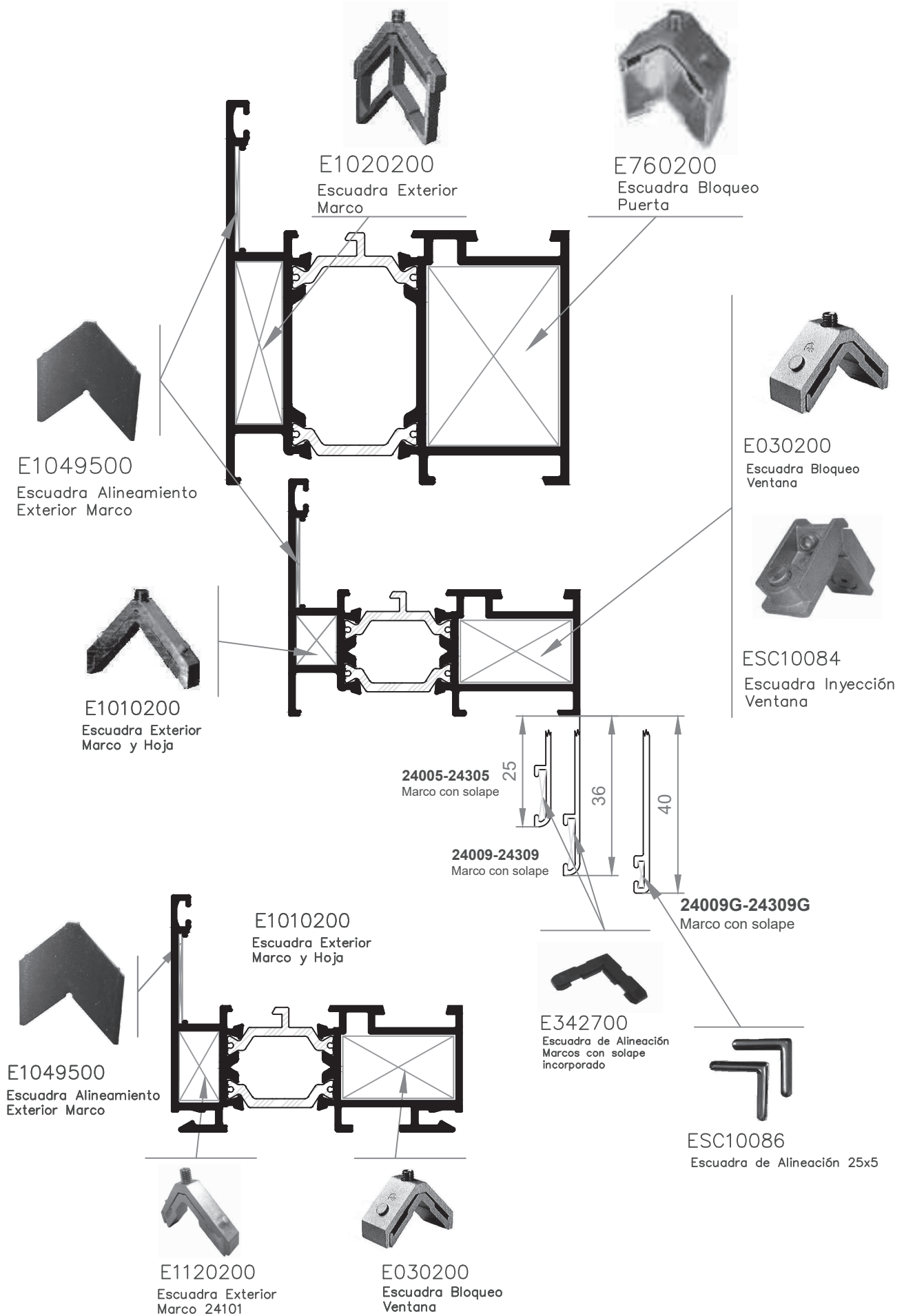

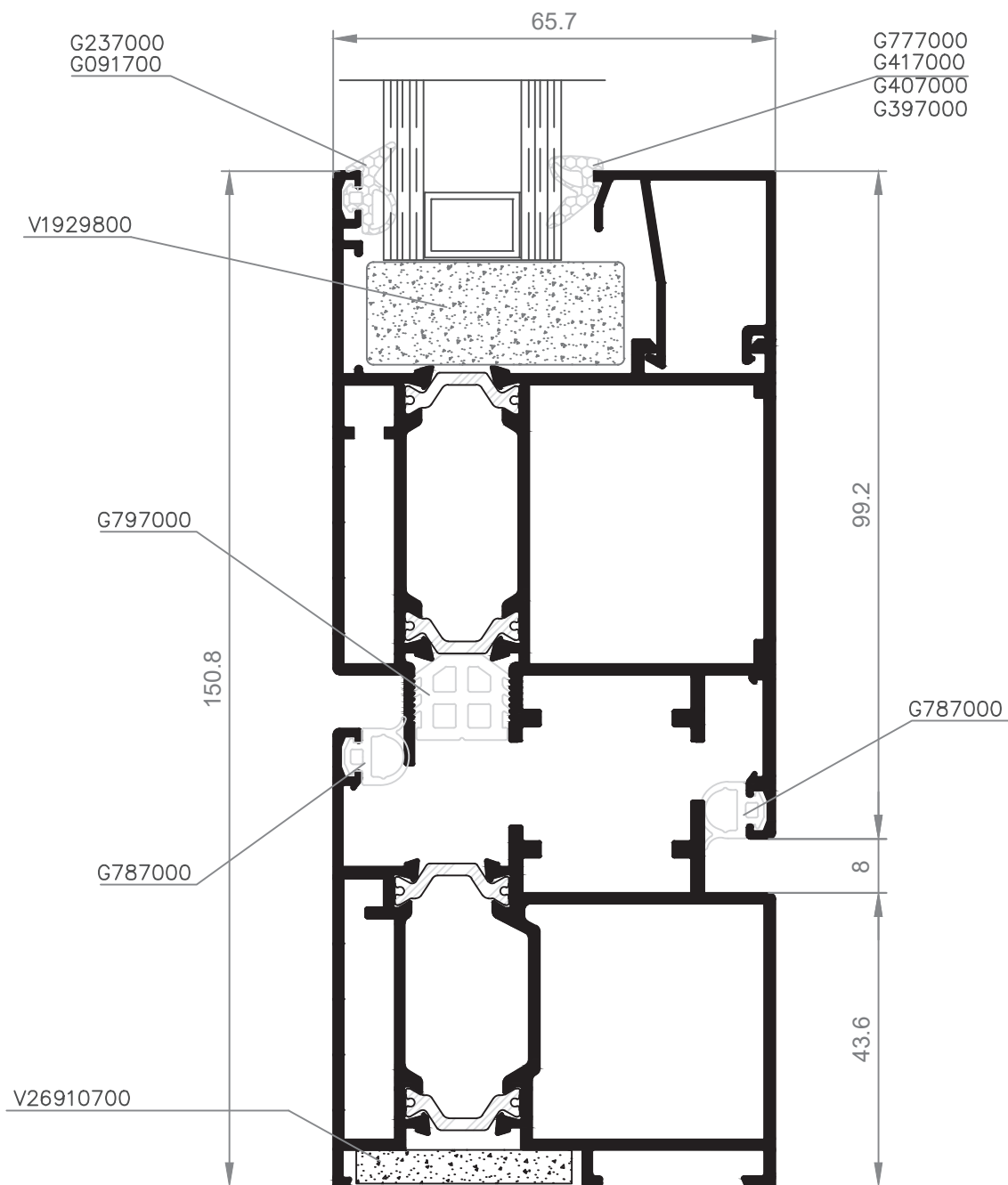

G787000
Junta batiente



G797000
Junta tapa canal

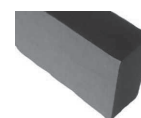

V1929800
Espuma Polietileno 40x15
Aislante Cristal
12 tiras 10m.



G417000 E4
G407000 E6
G397000 E8
Goma cuña para
acristalar precortadas
(3 tamaños)



G777000
Goma cuña acristalar
2mm.

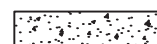

V26910700
Aislante Perimetral Marco



G091700
Goma acristalar E4



G237000
Goma acristalar perfil
acústica E3

DETALLE COLOCACION CALZOS PARA FIJOS V3198100

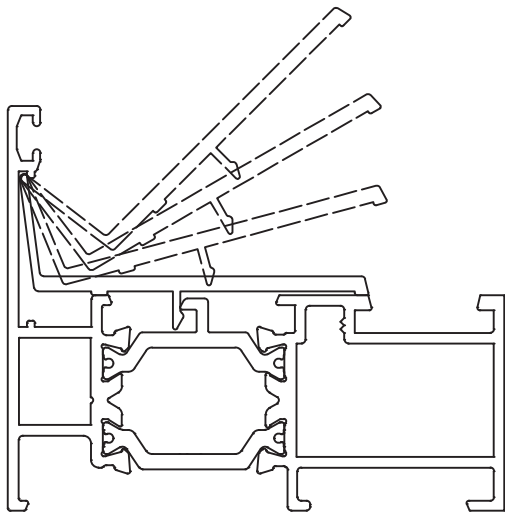

Colocación

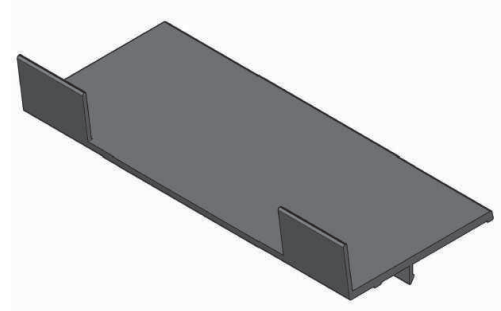

V31988100

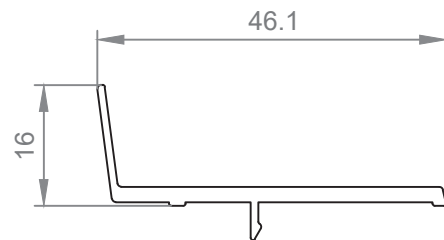

Sección

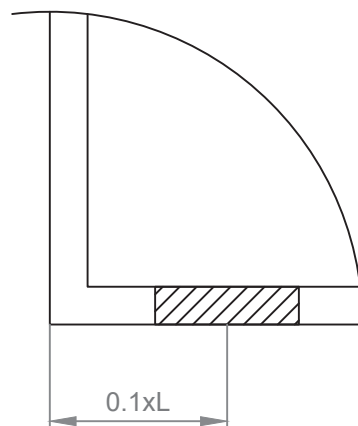

La distancia entre el eje de los calzos y el borde del vidrio, será aproximadamente $L/10$ (L = longitud del vidrio).

Nudo Lateral Puerta Apertura Exterior

Ref. B5741XX

Bisagra Monza puerta 2 cuerpos

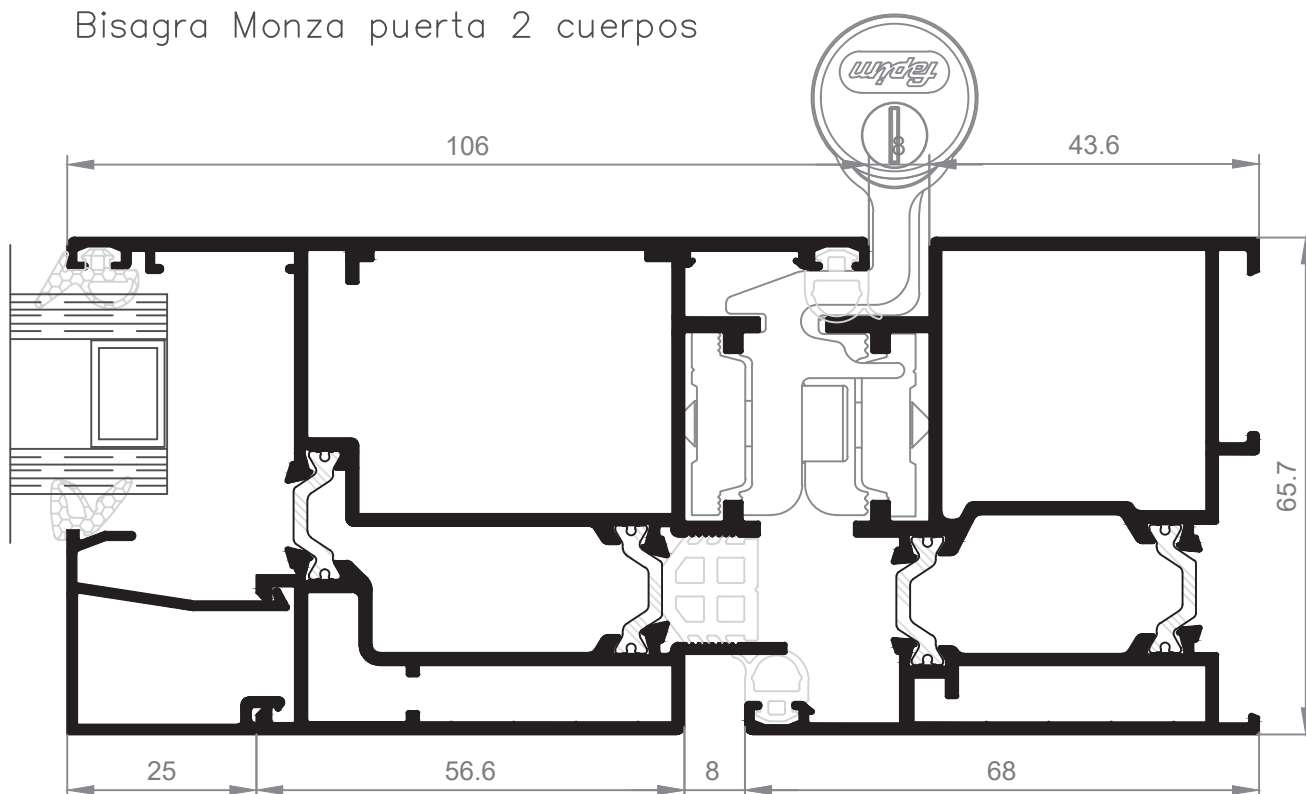

Posición pasador

Pasador 117mm
Ref. V2734100

Pasador 250mm
Ref. V2744100

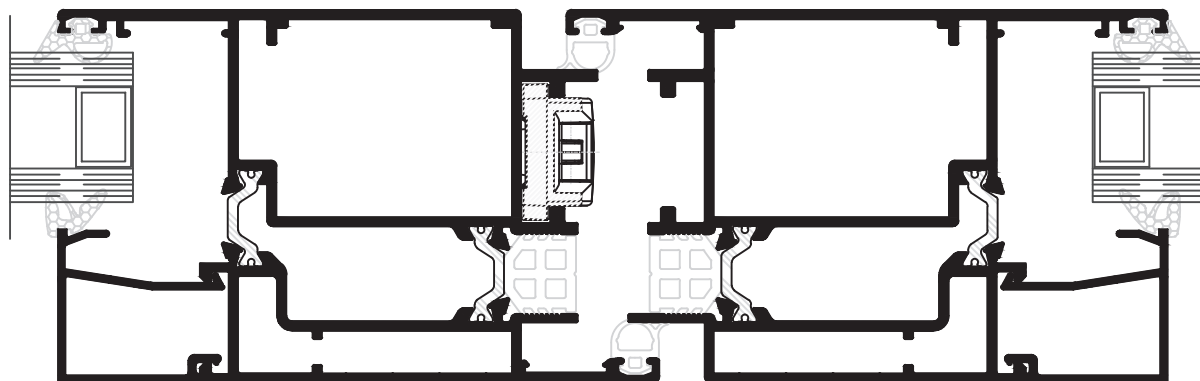
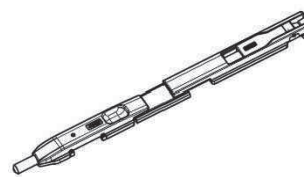
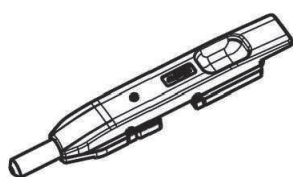

*Colocar pletinas de bisagra y pasador antes de ensamblar marco y hoja.

Encuentro Inferior para pasador

Ref. V227400

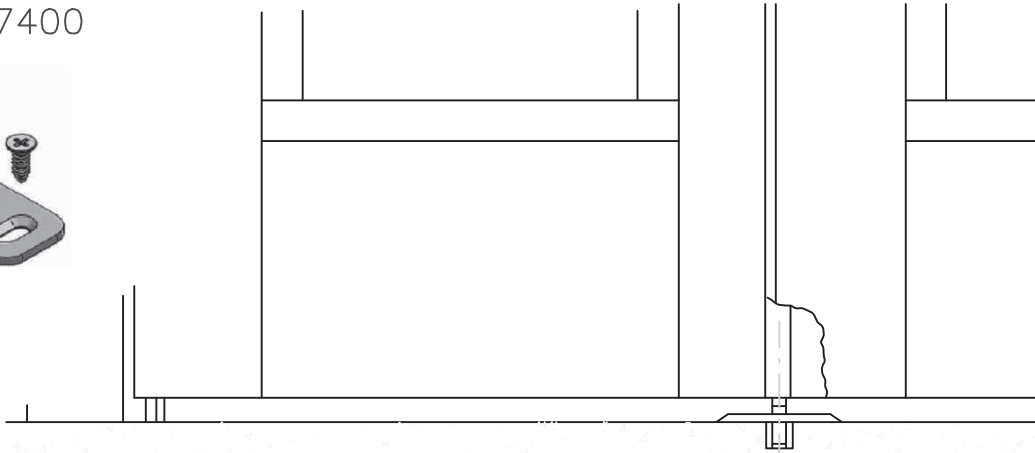
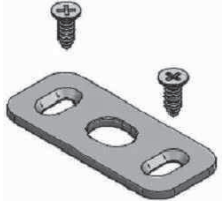

Posición encuentro para pasador en marco superior

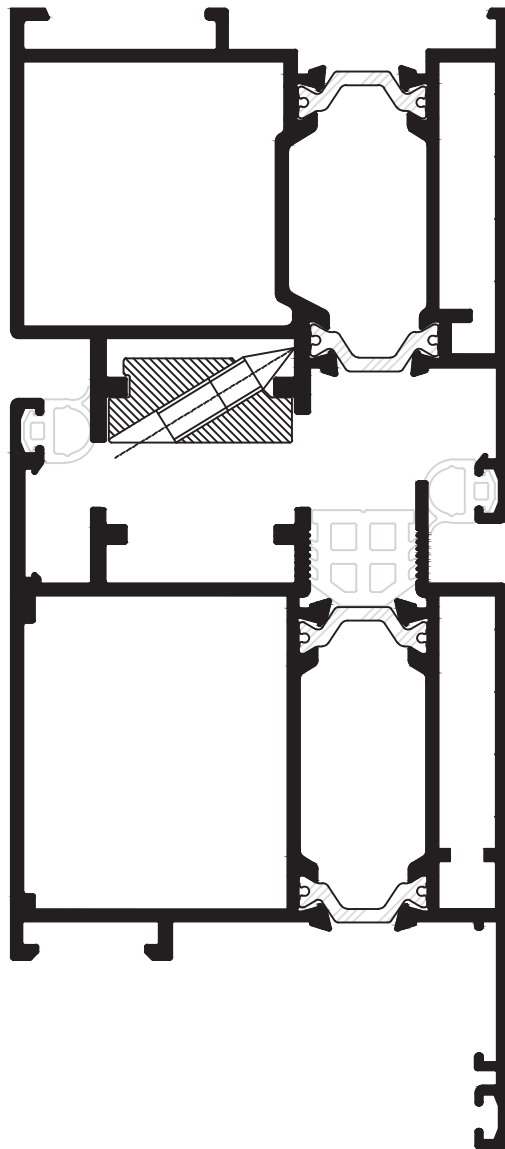

Ref. V2754100

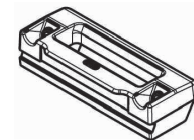

Nudo Marco-Hoja

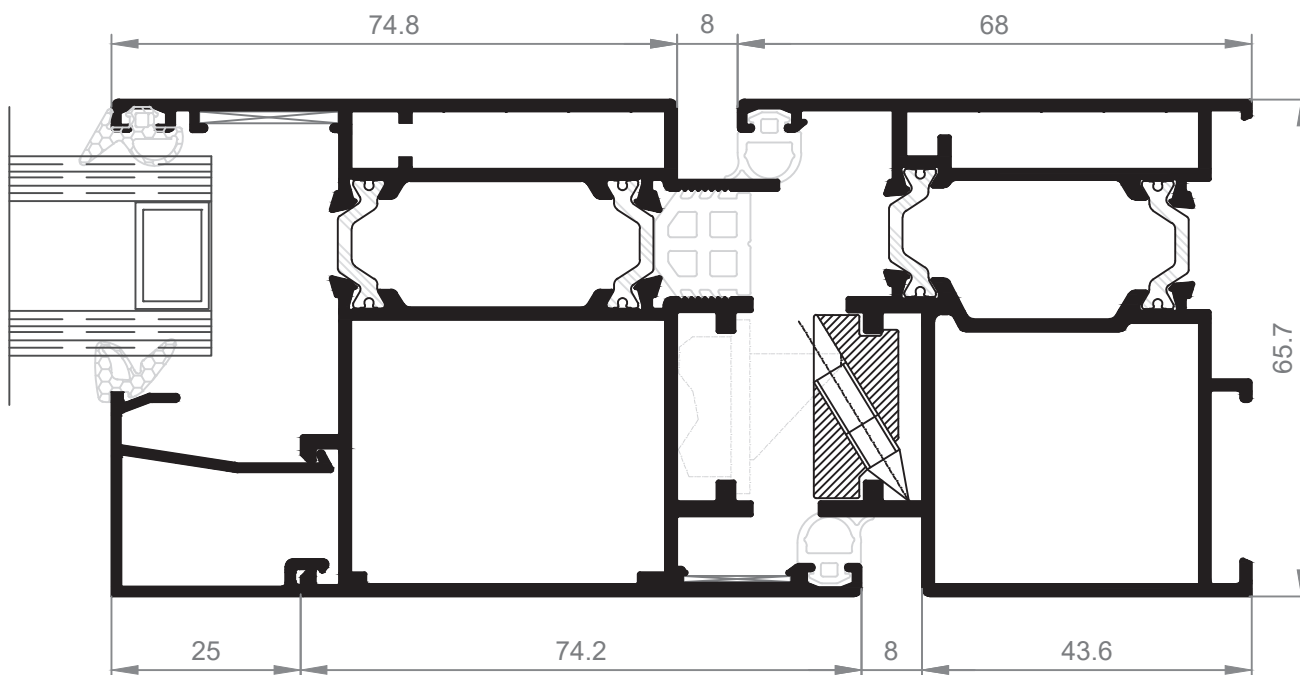

Nudo Central Puerta 2 Hojas Ap. Interior

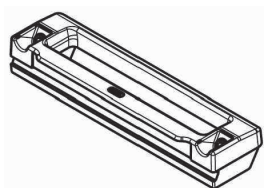
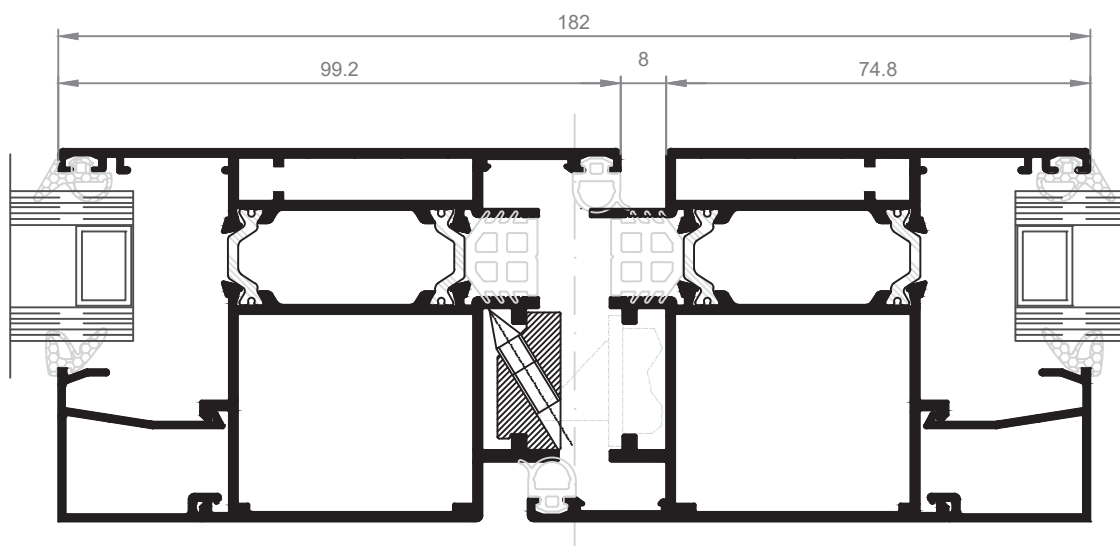

V2764100

Cerradura 3 puntos

4 unidades V2764100

Cerradura 1 punto

2 unidades V2764100

Nudo Marco-Hoja cerradura plana con cerradero en "U"

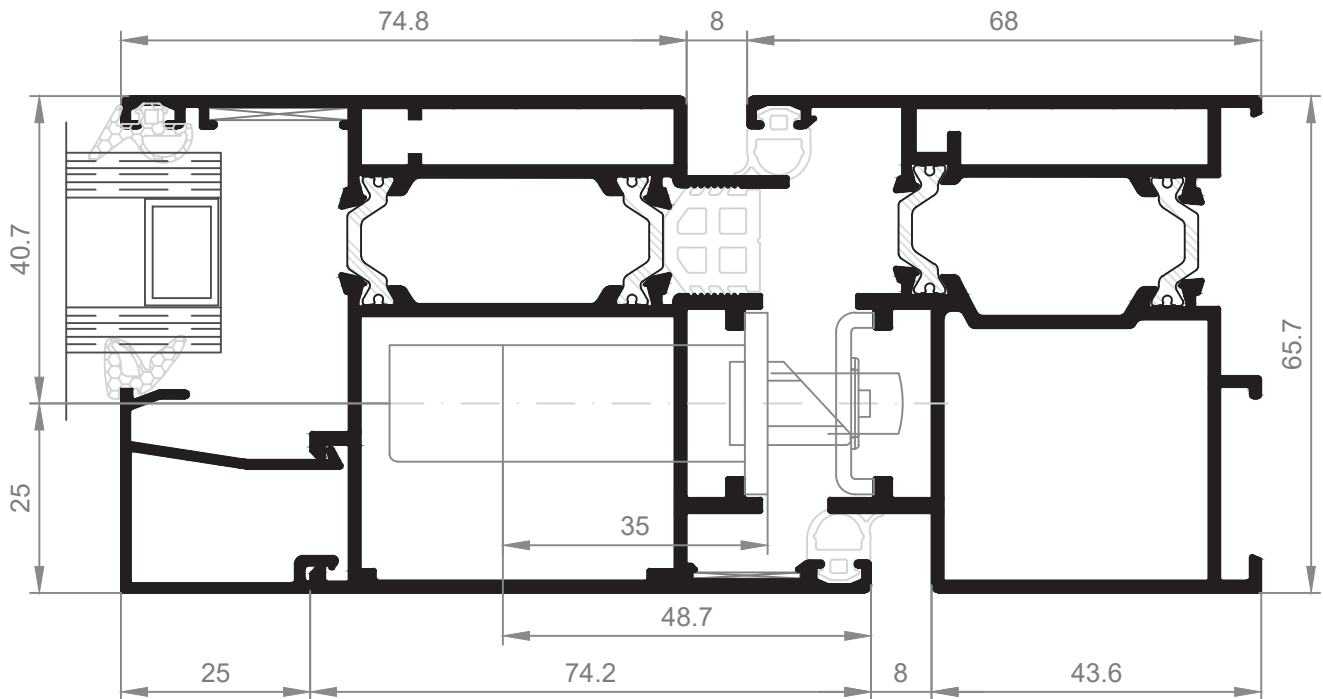

Nudo Central Puerta 2 Hojas Ap. Interior con cerradero en "U"

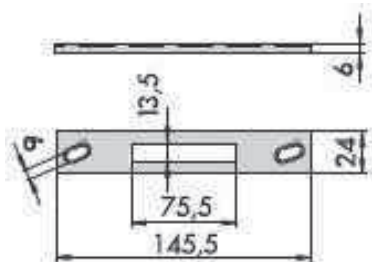
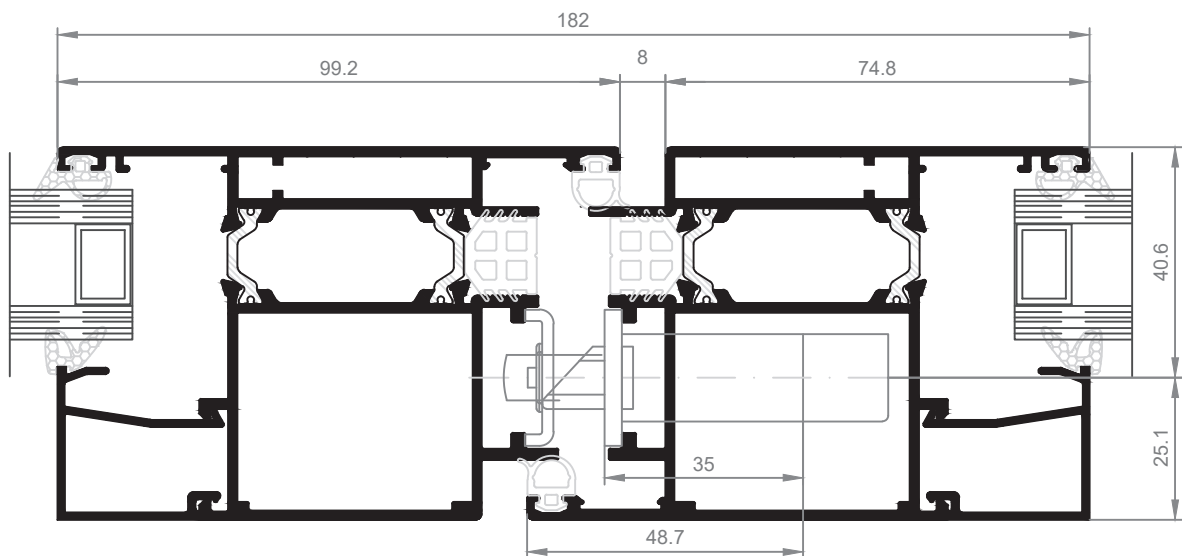

Cerradero fijo 3 puntos

1 unidad CE821900
2 unidades CE831900

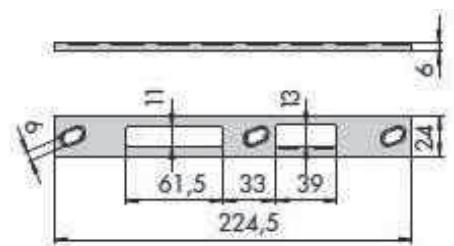

Cerradero fijo 1 punto

1 unidad CE821900

Nudo superior puerta con fijo

APERTURA INTERIOR

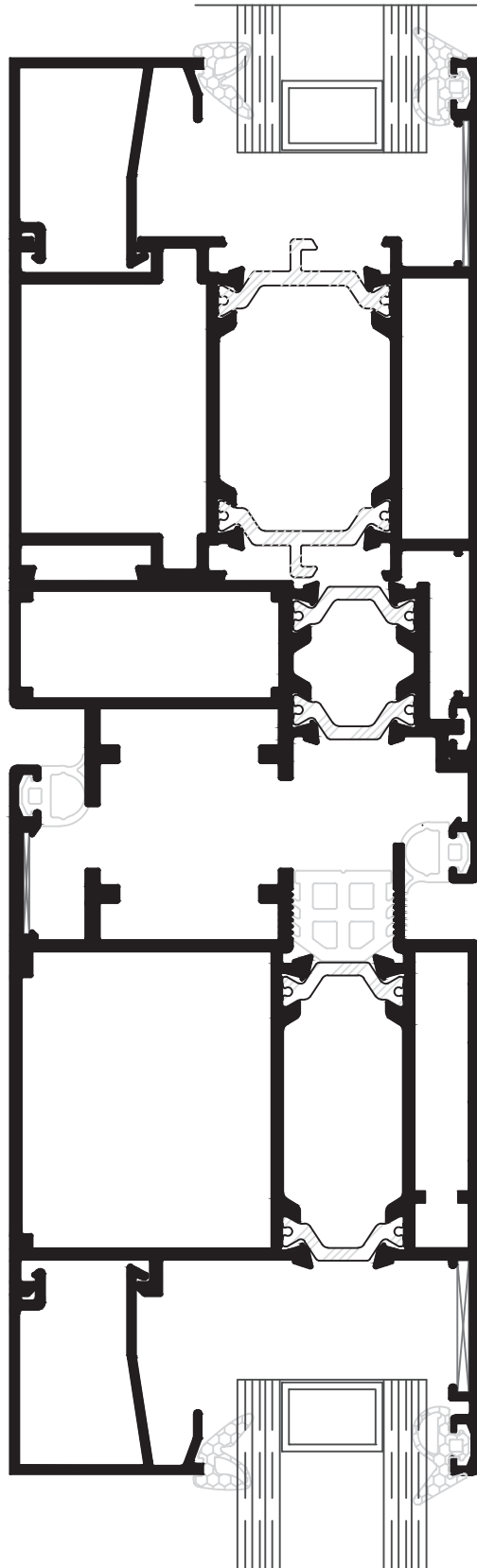

APERTURA EXTERIOR

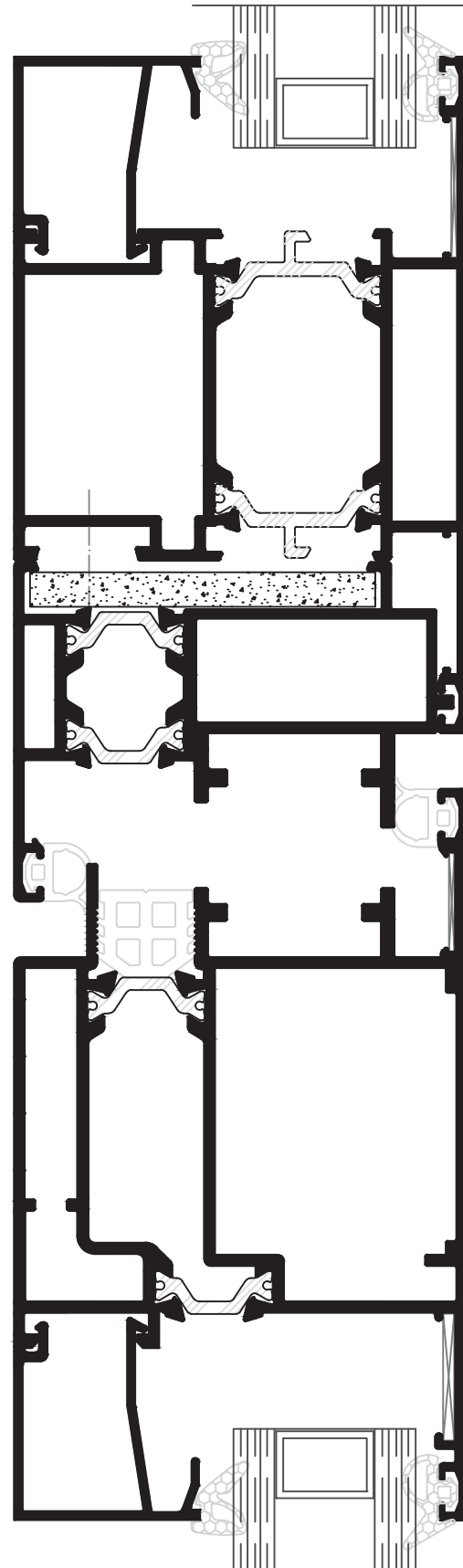

Colocación tapones en hoja apertura interior y exterior puerta 1 hoja

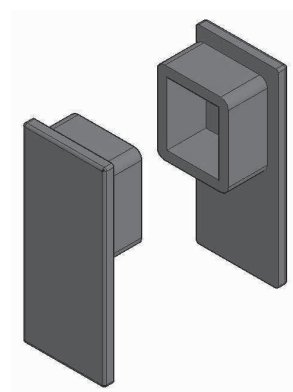
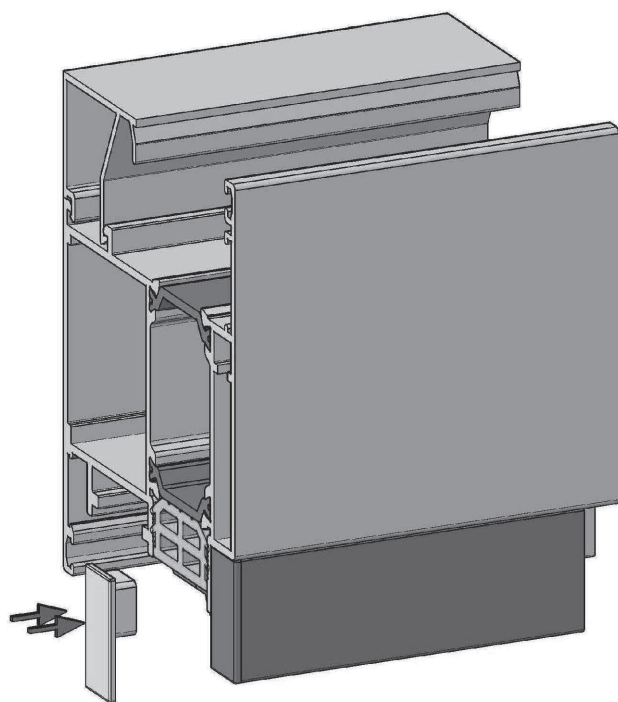

TP62108XX

Juego tapones 1 hoja
apertura interior y
exterior sin pisadera
(Blanco, Negro, Gris)

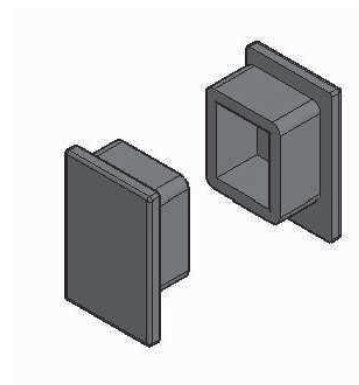
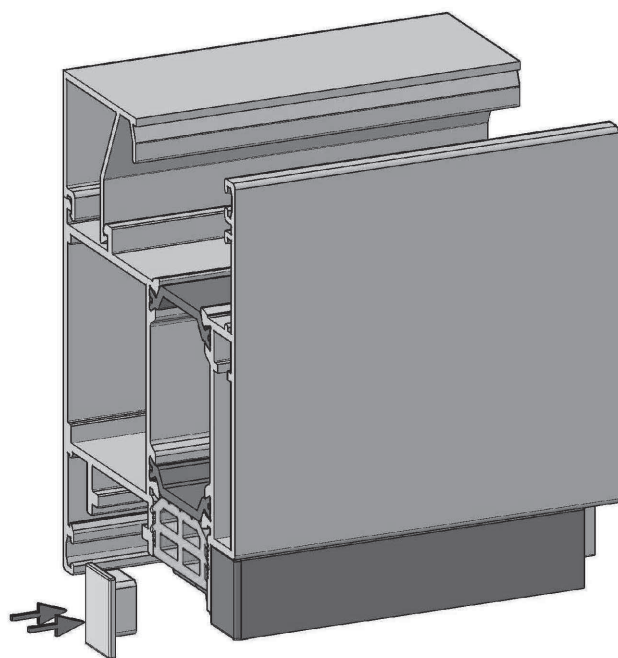

TP61108XX

Juego tapones 1 hoja
apertura interior y
exterior con pisadera
(Blanco, Negro, Gris)

**Pegar las tapas a los perfiles
con adhesivo cianoacrilato**

Colocación tapones en hoja apertura interior y exterior sin pisadera puerta 2 hojas

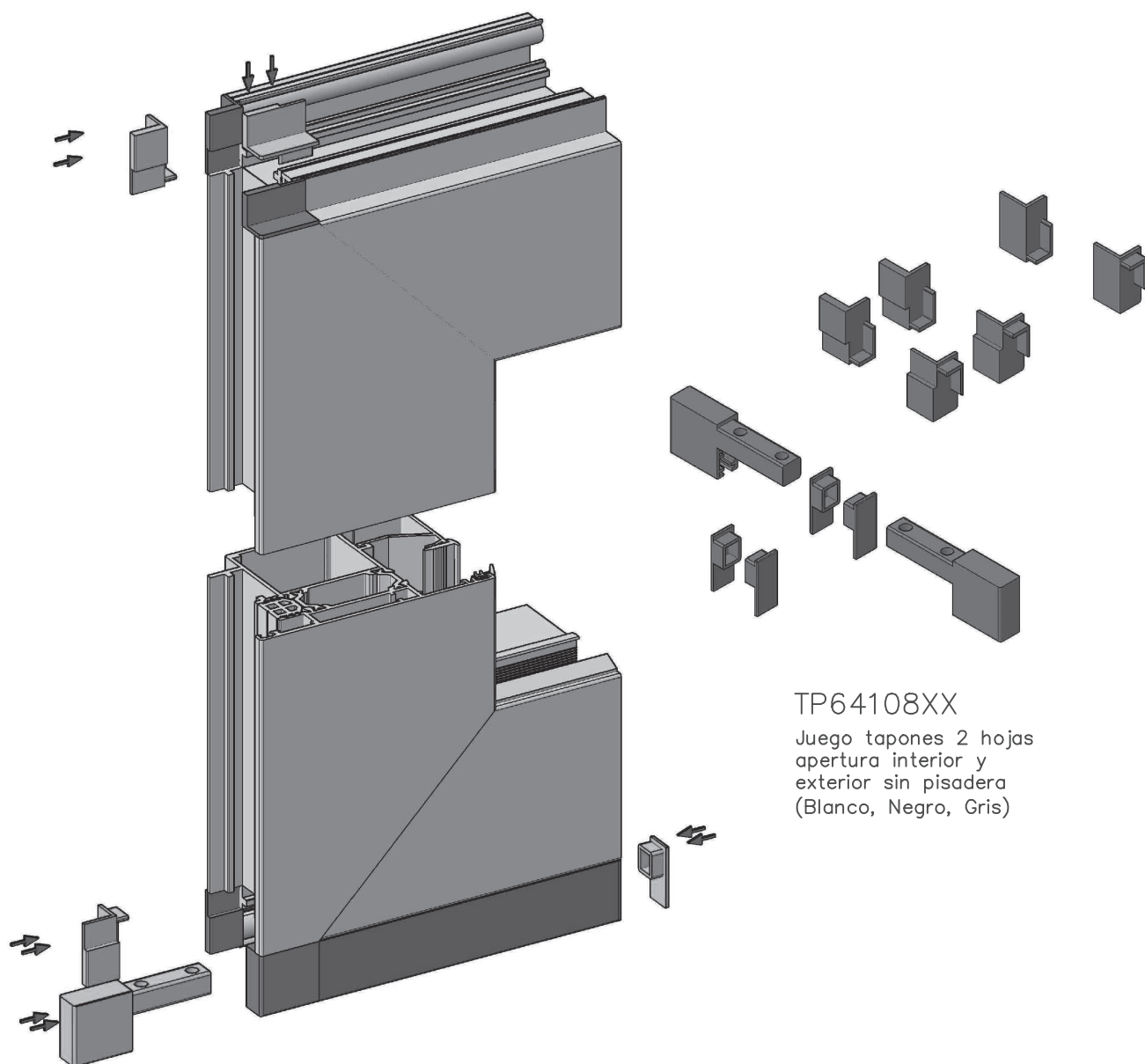

Pegar las tapas a los perfiles con adhesivo cianoacrilato. Inferior atornillar a perfil.

Colocación tapones en hoja apertura interior y exterior con pisadera puerta 2 hojas

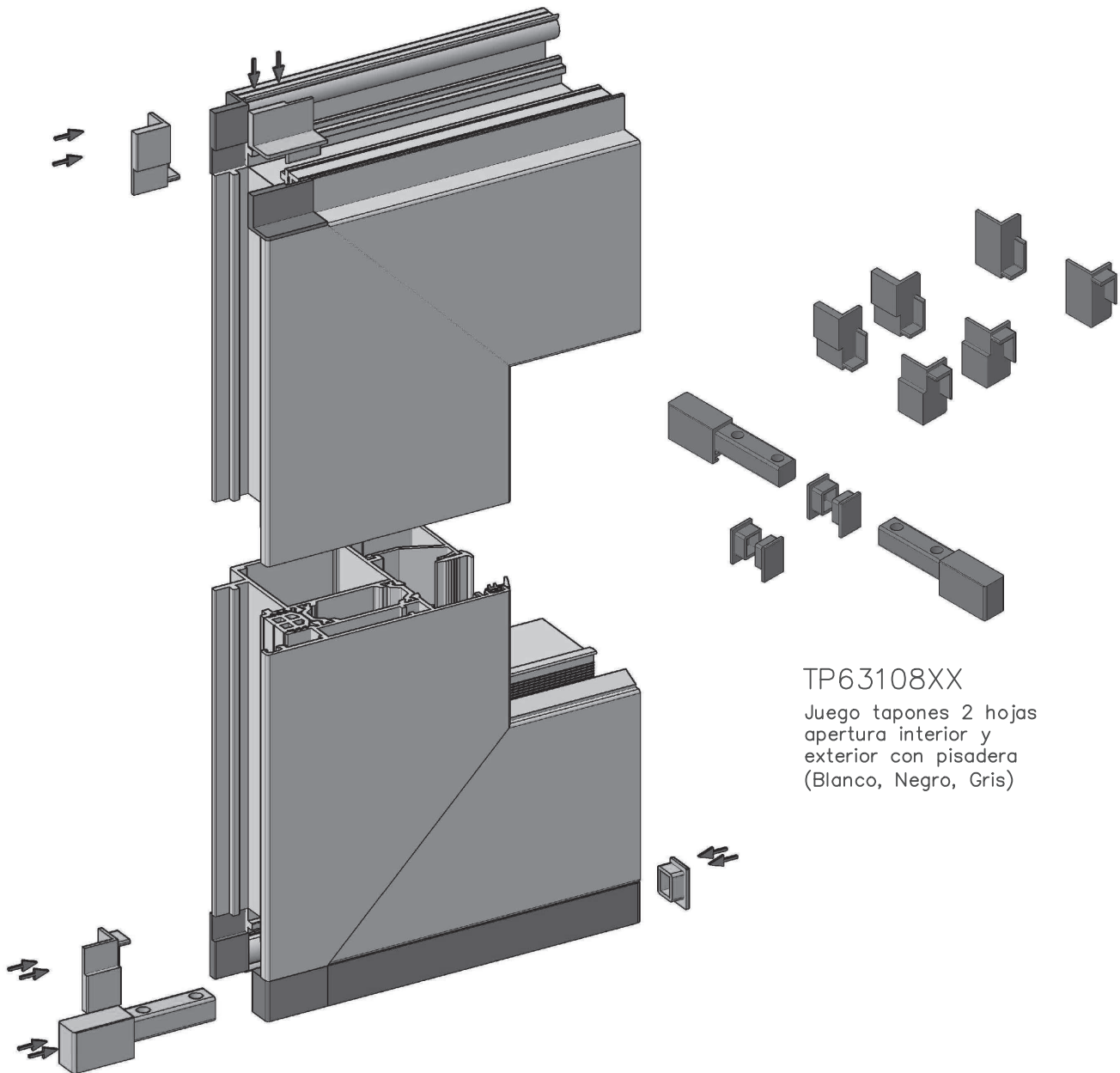

Pegar las tapas a los perfiles con adhesivo cianoacrilato. Inferior atornillar a perfil.

DETALLE COLOCACION PIEZAS REFUERZO UNION "T"

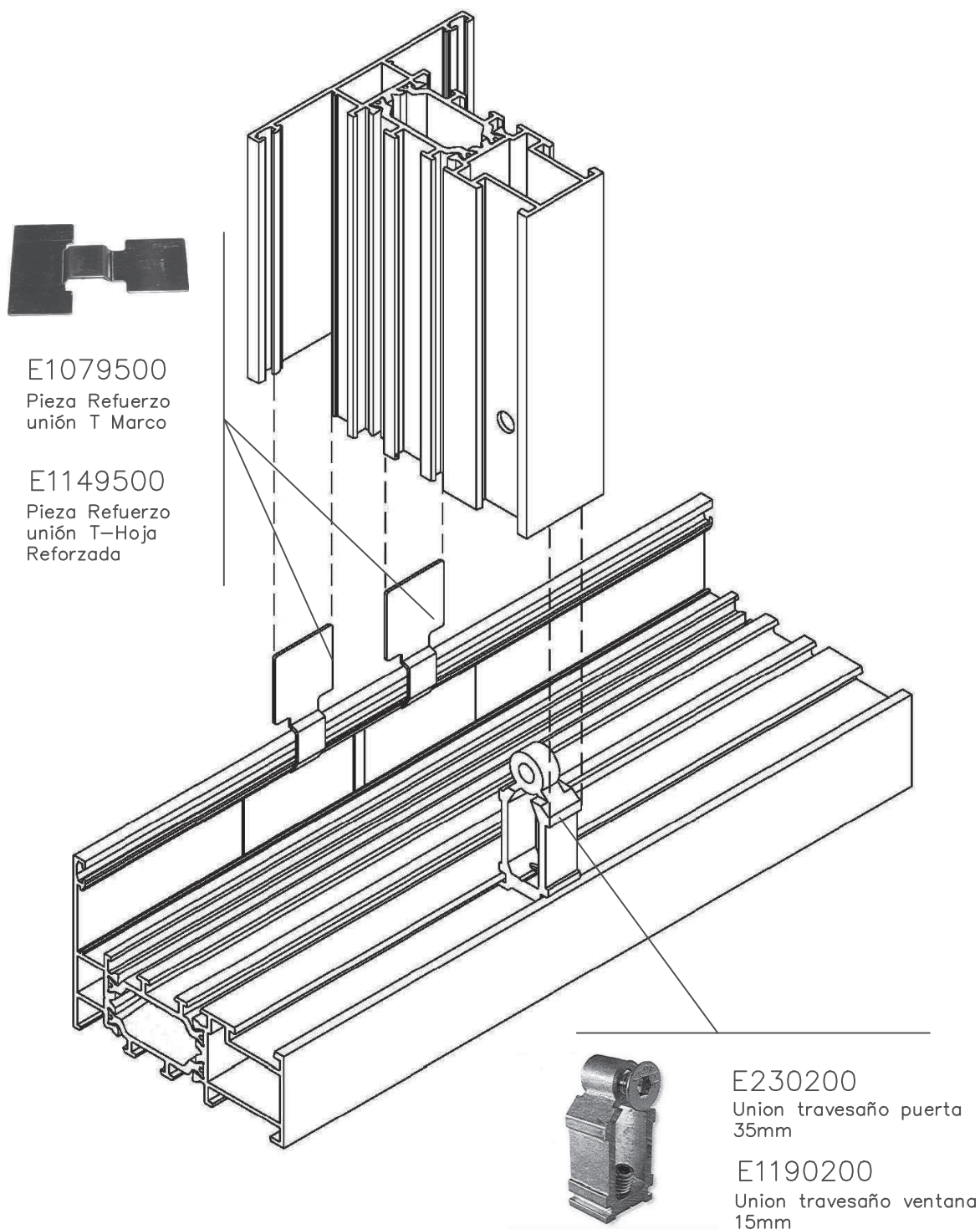



E1250200

Escuadra bloqueo marco ventana y hoja

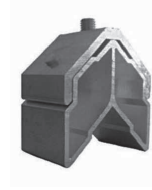

E1260200

Escuadra bloqueo marco puerta

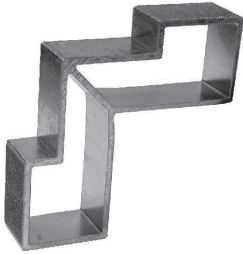

E1240000

Escuadra universal para hoja ventana.



E1280900

Escuadra balín marco ventana

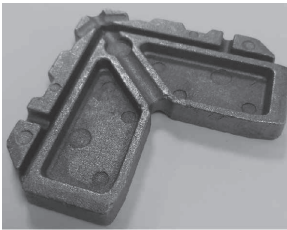

E1270900

Escuadra balín hoja



E630900

Escuadra alineamiento fijación hoja



E690200

Escuadra alineamiento exterior hoja



E1009500

Escuadra alineamiento interior hoja

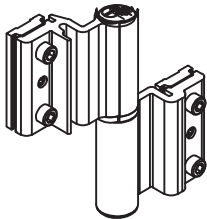

B5741XX

Bisagra MONZA puerta de 2 cuerpos



CE991900

Cilindro Europerfil 35/50 L-Larga



CE751900

Medio Cilindro Europerfil 50/10 L-Larga



CE1001900

Cilindro de Seguridad 35/50 L-Larga

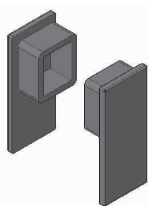

TP62108XX

Juego tapones 1 hoja apertura interior y exterior sin pisadera (Blanco, Negro, Gris)

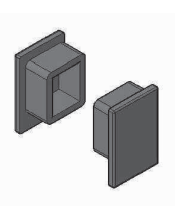

TP61108XX

Juego tapones 1 hoja apertura interior y exterior con pisadera (Blanco, Negro, Gris)

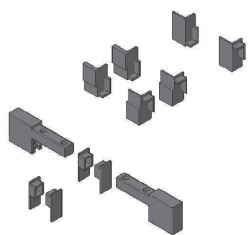

TP64108XX

Juego tapones 2 hojas
apertura interior y
exterior sin pisadera
(Blanco, Negro, Gris)

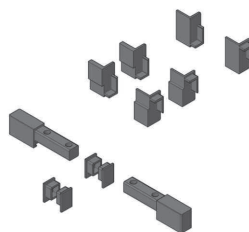

TP63108XX

Juego tapones 2 hojas
apertura interior y
exterior con pisadera
(Blanco, Negro, Gris)

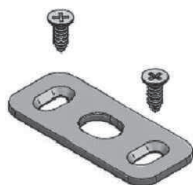

V227400

Cerradero inferior
suelo pasador

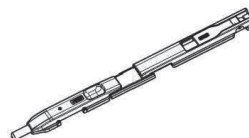

V2744100

Pasador VELOX largo
250mm.

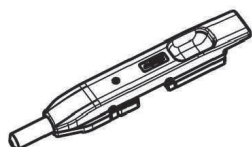

V2734100

Pasador VELOX corto
117mm.

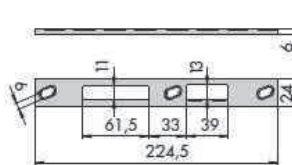

CE821900

Cerradero central
3puntos fijo

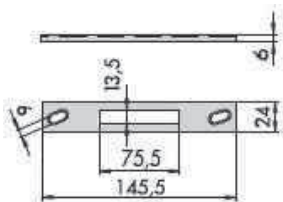

CE831900

Cerradero sup.-inf.
1 punto fijo

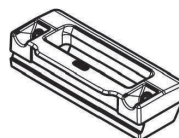

V2754100

Cerradero simple para
VELOX

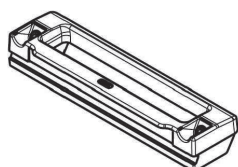

V2764100

Cerradero doble para
VELOX

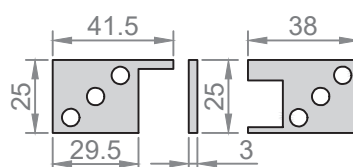

TP451900

Calce adaptable a
canal 25mm para
instalación de
cerradura y portero
automático



VC51

Cepillo inferior 7x6
Fin-Seal



PR050410

Prolongación para
pasador puerta 2000mm.



G787000

Junta Batiente



G797000

Junta tapa canal



G417000 E4
G407000 E6
G397000 E8

Goma cuña para
acristalar precortadas
(3 tamaños)



G237000

Goma acristalar perfil
acústica E3



G091700

Goma acristalar E4



G777000

Goma cuña acristalar
2mm.

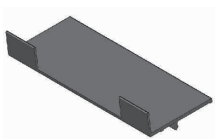

V3198100

Calzo para fijos

Leyenda de Colores de Accesorios:

01 – Blanco 02 – Negro
06 – Plata 12 – Inox.

Ejemplo:

Referencia base: C2170xx
Referencia blanco: C217001

Consultar colores disponibles en tarifa.

CONSEJOS DE MANTENIMIENTO

1.- Limpieza con agua y jabón.

La limpieza deberá realizarse con jabón y agua, **nunca** con productos abrasivos. Se aplicará con un paño húmedo un poco de jabón neutro a todos los elementos, secando posteriormente con un paño seco.

En puertas y ventanas correderas es importante mantener limpios los railes y las guías para no tener problemas de rodadura.

En zonas próximas al mar, tanto el aluminio como los herrajes (cierre, bisagras, etc.) se tendrán limpiar mas a menudo.

2.- Importante mantener en perfecto estado los **herrajes**.

Se aplicará aceite o vaselina para su correcto funcionamiento.

3.- Controlar los **elementos practicables**, para comprobar que no se ha desplazado ningún elemento de su lugar.

Importante revisar el buen funcionamiento de las **manillas**.



4.- En perfilería nueva o reposición de alguno de sus elementos, se deberán quitar las protecciones adhesivas para evitar posibles problemas por exposición directa al sol.

5.- Cuando se hagan obras, es recomendable proteger los elementos de aluminio para evitar posibles golpes o rayas que se pudieran producir.

6.- No utilizar:

- Útiles o herramientas que tengan filo.
- Lanas de acero o esponjas abrasivas.
- Líquidos o limpiadores para baños o disoluciones para lacas, ya que pueden ocasionar daños permanentes.

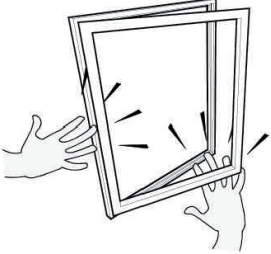
CONSEJOS DE SEGURIDAD

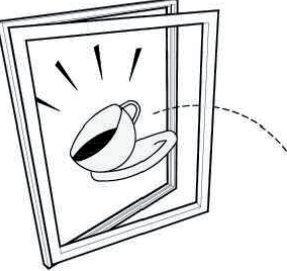
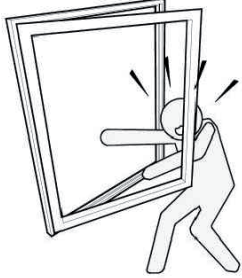
	<p align="center">Peligro de Atrapamiento</p> <p>Riesgo de atrapamiento entre marco y hoja al manipular las ventanas.</p>
	<p align="center">Peligro de Caída</p> <p>Peligro de caída si las hojas de las ventanas están abiertas. Especial vigilancia con los menores.</p>
	<p align="center">Peligro de Caída de Objetos</p> <p>Las ventanas abiertas pueden tener el peligro de la caída de objetos y lesiones, especialmente durante las operaciones de mantenimiento y limpieza.</p>
	<p align="center">Peligro de Golpes</p> <p>Riesgo de golpes con la hoja cuando esta se deja abierta. Desplazarse por debajo de ventanas abiertas puede ocasionar golpes con las hojas, especialmente los menores.</p>
	<p align="center">Peligro de Cierre Accidental</p> <p>Las ventanas batientes horizontales, pueden cerrarse repentinamente debido a golpes de viento, etc. pudiendo golpear al usuario.</p>